



# 2019 forecasting and planning scenarios, inputs, and assumptions

**August 2019**

For use in the 2019-20 Integrated System Plan, 2019 Electricity Statement of Opportunities for the National Electricity Market, and 2020 Gas Statement of Opportunities for eastern and south-eastern Australia

# Important notice

## PURPOSE

The publication of this Report concludes AEMO's consultation on AEMO's planning and forecasting inputs, scenarios and assumptions for use in its 2019-20 publications for the National Electricity Market (NEM). This report outlines the scenarios to be used by AEMO in 2019-20 publications, informing the Integrated System Plan (ISP) and Electricity Statement of Opportunities (ESOO).

This publication has been prepared by AEMO using information available at 1 July 2019. Information made available after this date may have been included in this publication where practical.

## DISCLAIMER

This document or the information in it may be subsequently updated or amended.

AEMO has made every effort to ensure the quality of the information in this document but cannot guarantee its accuracy or completeness.

Anyone proposing to use the information in this document should independently verify and check its accuracy, completeness and suitability for purpose, and obtain independent and specific advice from appropriate experts.

Accordingly, to the maximum extent permitted by law, AEMO and its officers, employees and consultants involved in the preparation of this document:

- make no representation or warranty, express or implied, as to the currency, accuracy, reliability or completeness of the information in this document; and
- are not liable (whether by reason of negligence or otherwise) for any statements or representations in this document, or any omissions from it, or for any use or reliance on the information in it.

## VERSION CONTROL

Version	Release date	Changes
1	16/08/2019	Initial release

# Executive summary

AEMO delivers a range of planning and forecasting publications for the National Electricity Market (NEM), including the NEM Electricity Statement of Opportunities (ESOO), the Gas Statement of Opportunities (GSOO) and the Integrated System Plan (ISP)<sup>1</sup>. This report contains descriptions of the 2019-20 scenarios, inputs, and assumptions which will be used in AEMO's 2019-20 NEM Planning and Forecasting publications.

## 2019 NEM Planning and Forecasting consultation

AEMO published the 2019 Planning and Forecasting Consultation Paper for stakeholder consultation on 5 February 2019. AEMO received 25 submissions from industry, academia, individuals, and small business, which provided feedback on the key modelling inputs and assumptions, the proposed scenarios for 2019, and the consultation process itself. AEMO received additional feedback from stakeholders at Planning and Forecasting workshops and forums.

AEMO has considered this feedback in determining the scenarios, inputs, and assumptions. This report describes the scenario narratives and key input parameters driving each scenario. A separate report provides AEMO's response to stakeholder feedback<sup>2</sup> and explains how AEMO has taken this feedback into account.

## 2019-20 scenarios

The use of scenario planning is an effective practice to manage investment and business risks when planning in a highly uncertain environment, particularly through disruptive transitions. Scenarios are a critical aspect of forecasting, providing the information needed to assess future risks, opportunities, and development needs in the energy industry. It is vital that the dimensions of scenarios chosen cover the potential breadth of plausible futures impacting the energy sector and capture the key uncertainties and material drivers of these possible futures in an internally consistent way.

For forecasting and planning purposes, five scenarios have been developed that provide a suitably wide range of possible industry outcomes differing with respect to the growth in grid-scale renewable generation resources, the uptake of distributed energy resources, and the level and breadth of decarbonisation policies (see Figure 1):

- **The Central scenario** reflects the **current transition of the energy industry** under current policy settings and technology trajectories, where the transition from fossil fuels to renewable generation is generally led by market forces and supported by current federal and state government policies<sup>3</sup>.
- **The Slow Change** scenario reflects a **general slow-down of the energy transition**. It is characterised by slower advancements in technology and reductions in technology costs, low population growth, and low political, commercial, and consumer motivation to make the upfront investments required for significant emissions reduction.

---

<sup>1</sup> For National Electricity Rules purposes, the ISP will largely incorporate the information required to be contained in the National Transmission Network Development Plan (NTNDP). This consultation incorporates the formal requirements for consultation on NTNDP inputs, material issues, and other matters specified in the rules prior to the development of an NTNDP.

<sup>2</sup> AEMO, 2019 Planning and Forecasting Consultation responses on Scenarios, Inputs, Assumptions and Methodology, available at [https://www.aemo.com.au/-/media/Files/Electricity/NEM/Planning\\_and\\_Forecasting/Inputs-Assumptions-Methodologies/2019/2019-Planning-and-Forecasting-Consultation-Responses.pdf](https://www.aemo.com.au/-/media/Files/Electricity/NEM/Planning_and_Forecasting/Inputs-Assumptions-Methodologies/2019/2019-Planning-and-Forecasting-Consultation-Responses.pdf).

<sup>3</sup> Includes existing Federal emissions reduction policy to reduce Australia's emissions by 26% by 2030 economy wide, state renewable energy targets, pumped hydro initiatives (Snowy 2.0 and Battery of the Nation), and various policies affecting the scale and timing of energy efficiency adoption and distributed energy resources (DER) penetration. Section 2.3 provides more detail.

- The **High DER** scenario reflects a more **rapid consumer-led transformation** of the energy sector, relative to the Central scenario. It represents a highly digital world where technology companies increase the pace of innovation in easy-to-use, highly interactive, engaging technologies. This scenario includes reduced costs and increased adoption of distributed energy resources (DER), with automation becoming commonplace, enabling consumers to actively control and manage their energy costs while existing generators experience an accelerated exit. It is also characterised by widespread electrification of the transport sector.
- The **Fast Change** scenario reflects a **rapid technology-led transition**, particularly at grid scale, where advancements in large-scale technology improvements and targeted policy support reduce the economic barriers of the energy transition. This includes coordinated national and international action towards achieving emissions reductions, leading to manufacturing advancements, automation, accelerated exit of existing generators, and integration of transport into the energy sector.
- The **Step Change** scenario reflects **strong action on climate change** that leads to a step change reduction of greenhouse gas emissions. In this scenario, aggressive global decarbonisation leads to faster **technological improvements**, accelerated exit of existing generators, greater electrification of the transport sector with increased infrastructure developments, energy digitalisation, and **consumer-led innovation**.

**Figure 1 Scenarios determined for use in AEMO's 2019-20 forecasting and planning publications**

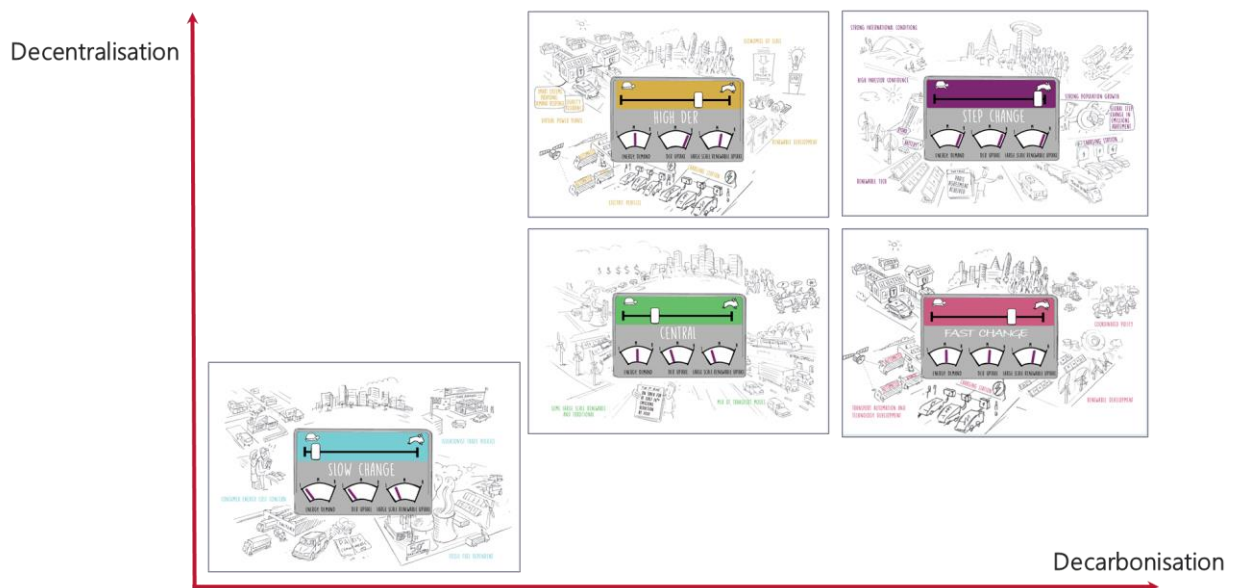

The scenarios inform and support the realisation of economically efficient solutions to support the energy system in transition. They inform risks and enable prudent decisions to be made that take risks into account, enabling developments that adapt to differences in the pace or nature of change. The ISP uses scenarios to develop a whole-of-system plan that manages the ultimate cost and risk of this transition in the long-term interests of customers.<sup>4</sup>

AEMO will use these scenarios to assess potential development paths using a form of least regrets methodology, designed to accommodate uncertainty by examining the consequences of each development path under each scenario. Additional sensitivities may complement the scenarios, to identify the magnitude of impact of key assumptions and test specific decisions that may be taken in the near future.

<sup>4</sup> The ISP identifies the optimal development path for the power system based on an engineering and economic assessment of infrastructure and resource costs. It assumes that the market is designed to deliver efficient outcomes.

## 2019-20 inputs and assumptions

This report describes key inputs and assumptions in relation to:

- Components for forecasting energy consumption.
- Policy settings affecting energy supplies.
- Technical and economical settings affecting energy supply.
- Existing generation assumptions.
- Uptake scenarios of DER.
- Renewable energy zones (REZs).
- Interconnector augmentation options.
- Non-network technologies.
- System security constraints.
- Network losses and Marginal Loss Factor (MLF) modelling.
- Gas modelling.

Further information on inputs and assumptions to be used in AEMO's 2019-20 planning and forecasting publications can be found in AEMO's 2019 Inputs and Assumptions Workbook<sup>5</sup>. Methodologies for demand forecasting, market modelling, assessing system strength, and inertia requirements are contained in supplementary materials on AEMO's Inputs and Assumptions web page<sup>6</sup>.

---

<sup>5</sup> The 2019 AEMO Inputs and Assumptions Workbook provides detail of all modelling inputs affecting supply and demand of electricity in the NEM. It is at [https://www.aemo.com.au/-/media/Files/Electricity/NEM/Planning\\_and\\_Forecasting/Inputs-Assumptions-Methodologies/2019/2019-Input-and-Assumptions-workbook.xlsx](https://www.aemo.com.au/-/media/Files/Electricity/NEM/Planning_and_Forecasting/Inputs-Assumptions-Methodologies/2019/2019-Input-and-Assumptions-workbook.xlsx).

<sup>6</sup> AEMO's inputs, assumptions, and methodologies for planning and forecasting activities are available at <https://www.aemo.com.au/Electricity/National-Electricity-Market-NEM/Planning-and-forecasting/Inputs-Assumptions-and-Methodologies>.

# Contents

<b>Executive summary</b>	<b>3</b>
<b>1. Introduction</b>	<b>8</b>
1.1 Consultation process	9
1.2 Supplementary material	9
<b>2. Scenarios</b>	<b>11</b>
2.1 Scenario overview	11
2.2 Scenario narratives	12
2.3 Key scenario parameters	19
2.4 Sensitivity analysis	22
<b>3. Inputs and assumptions</b>	<b>23</b>
3.1 Key components for forecasting energy consumption	23
3.2 Key policy settings	30
3.3 Key technical and economic settings affecting energy supply	34
3.4 Existing generator assumptions	42
3.5 Renewable energy zones	46
3.6 Network considerations	53
3.7 Gas modelling assumptions	56
<b>4. Inertia and system strength requirements methodologies</b>	<b>58</b>
<b>5. Applying the scenarios in decision-making</b>	<b>59</b>

## Tables

Table 1	Additional information and data sources	9
Table 2	2019 scenario policy settings	19
Table 3	2019-20 scenario dimensions	20
Table 4	Identified 2019-20 ISP sensitivities	22
Table 5	Candidate generation technology options	35
Table 6	NEM locational cost factors	38
Table 7	Regional build costs of pumped hydro for different storage sizes	41

# Figures

Figure 1	Scenarios determined for use in AEMO's 2019-20 forecasting and planning publications	4
Figure 2	Consultation milestones	9
Figure 3	Scenarios determined for examination in the 2019-20 Integrated System Plan	11
Figure 4	Central scenario narrative	12
Figure 5	Slow Change scenario narrative	14
Figure 6	High DER narrative	15
Figure 7	Fast Change narrative	16
Figure 8	Step Change narrative	18
Figure 9	Forecast effective capacity of rooftop PV installations (MW)	24
Figure 10	Forecast effective capacity of installed consumer battery capacity (megawatt hours [MWh])	25
Figure 11	Forecast electricity consumption from electric vehicles (MWh)	25
Figure 12	Coordinated battery capacity in terms of operating as VPPs	26
Figure 13	Forecast economic growth in Gross State Product of NEM regions	27
Figure 14	Forecast energy savings from energy efficiency measures impacting business and residential sectors	28
Figure 15	Cumulative NEM electricity sector emissions to 2050 that will be input as carbon budgets	31
Figure 16	Climate pathways modelled across ISP scenarios	32
Figure 17	Build cost projection for selected technologies for 4-degrees scenario (\$/kW)	36
Figure 18	Generation technology costs across the scenarios	37
Figure 19	Locational cost map	39
Figure 20	Regional gas prices to apply in the Central scenario for new entrant CCGT plant	44
Figure 21	Regional coal prices to apply in the Central scenario	45
Figure 22	REZ candidates for 2019-20 ISP	48
Figure 23	Weighted wind (left) and solar (right) resource heat map	49
Figure 24	Division of REZ costs	50
Figure 25	Loop flow resulting from South Australia to New South Wales connection	55
Figure 26	Region boundary before (left) and after (right) possible boundary shift	56



# 1. Introduction

AEMO produces several publications that inform the decision support function for stakeholders, and are coordinated and integrated in AEMO's modelling to provide its forecasting and planning advice:

- **Electricity Statement of Opportunities (ESOO):** The ESOO provides technical and market data that informs the decision-making processes of market participants, new investors, and jurisdictional bodies as they assess opportunities in the National Electricity Market (NEM) over a 10-year outlook period.
- **Gas Statement of Opportunities (GSOO):** The GSOO provides AEMO's forecast of annual gas consumption and maximum gas demand, and reports on the adequacy of eastern and south-eastern Australian gas markets to supply forecast demand over a 20-year outlook period.
- **Integrated System Plan (ISP):** The ISP is a whole-of-system plan that provides an integrated roadmap for the efficient development of the NEM over the next 20 years and beyond. Its primary objective is to maximise value to end consumers by designing the lowest cost secure and reliable energy system capable of meeting any emissions trajectory determined by policy-makers at an acceptable level of risk<sup>7</sup>. It fully utilises the opportunities provided from existing technologies and anticipated innovations in distributed energy resources (DER), large-scale generation, networks, and coupled sectors such as gas and transport.

Many uncertainties face the energy sector:

- The role of consumers in the energy market is evolving as DER, new technological innovations, and customer behaviours change.
- Other industries, such as the transportation industry, are increasingly electrifying their energy supplies and are thus having a direct impact on the energy sector.
- Existing supply sources, particularly thermal generators, are ageing and approaching the end of their technical lives. These resources must be replaced while a reliable and secure power system is maintained that meets consumer demand at an affordable cost as well as public policy requirements.

AEMO uses a scenario analysis approach to investigate the direction and magnitude of shifts impacting the energy sector, and the economically efficient level of infrastructure necessary to support the future energy needs of consumers. This report outlines the scenarios to be modelled by AEMO across its planning and forecasting publications, to best inform future investment or divestment decisions. It also describes key inputs and assumptions to be used in AEMO's modelling. It is complemented by AEMO's:

- 2019 Inputs and Assumptions Workbook<sup>8</sup>.
- 2019 Planning and Forecasting Consultation Responses on scenarios, inputs, assumptions and methodology report (2019 Consultation Responses Report)<sup>9</sup>.
- 2019 Market Modelling Methodology Paper<sup>10</sup>.
- 2018 Demand Forecasting Methodology Information Paper<sup>11</sup>.

---

<sup>7</sup> The ISP identifies the optimal development path for the power system based on an engineering and economic assessment of infrastructure and resource costs. It assumes that the market is designed to deliver efficient outcomes.

<sup>8</sup> The 2019 AEMO Inputs and Assumptions Workbook provides detail of all modelling inputs affecting supply and demand of electricity in the NEM. It is at [https://www.aemo.com.au/-/media/Files/Electricity/NEM/Planning\\_and\\_Forecasting/Inputs-Assumptions-Methodologies/2019/2019-Input-and-Assumptions-workbook.xlsx](https://www.aemo.com.au/-/media/Files/Electricity/NEM/Planning_and_Forecasting/Inputs-Assumptions-Methodologies/2019/2019-Input-and-Assumptions-workbook.xlsx).

<sup>9</sup> The 2019 Planning and Forecasting Consultation responses are detailed in the following report: [https://www.aemo.com.au/-/media/Files/Electricity/NEM/Planning\\_and\\_Forecasting/Inputs-Assumptions-Methodologies/2019/2019-Planning-and-Forecasting-Consultation-Responses.pdf](https://www.aemo.com.au/-/media/Files/Electricity/NEM/Planning_and_Forecasting/Inputs-Assumptions-Methodologies/2019/2019-Planning-and-Forecasting-Consultation-Responses.pdf).

<sup>10</sup> AEMO, Market Modelling Methodology Paper, at [https://www.aemo.com.au/-/media/Files/Electricity/NEM/Planning\\_and\\_Forecasting/Inputs-Assumptions-Methodologies/2019/Market-Modelling-Methodology-Paper.pdf](https://www.aemo.com.au/-/media/Files/Electricity/NEM/Planning_and_Forecasting/Inputs-Assumptions-Methodologies/2019/Market-Modelling-Methodology-Paper.pdf).

<sup>11</sup> AEMO, Demand Forecasting Methodology Information Paper, at [https://www.aemo.com.au/-/media/Files/Electricity/NEM/Planning\\_and\\_Forecasting/NEM\\_ESOO/2018/Electricity-Demand-Forecasting-Methodology-Information-Paper.pdf](https://www.aemo.com.au/-/media/Files/Electricity/NEM/Planning_and_Forecasting/NEM_ESOO/2018/Electricity-Demand-Forecasting-Methodology-Information-Paper.pdf).



## 1.1 Consultation process

The scenarios, inputs, assumptions and methods that apply for AEMO’s 2019-20 forecasting and planning publications have been developed through an extensive consultation process that commenced in February 2019. Views have been sought from a broad collection of stakeholders throughout this period through written submissions, in-person discussions, workshop participation, webinars and briefings.

Figure 2 below shows key engagement milestones during this time.

**Figure 2 Consultation milestones**

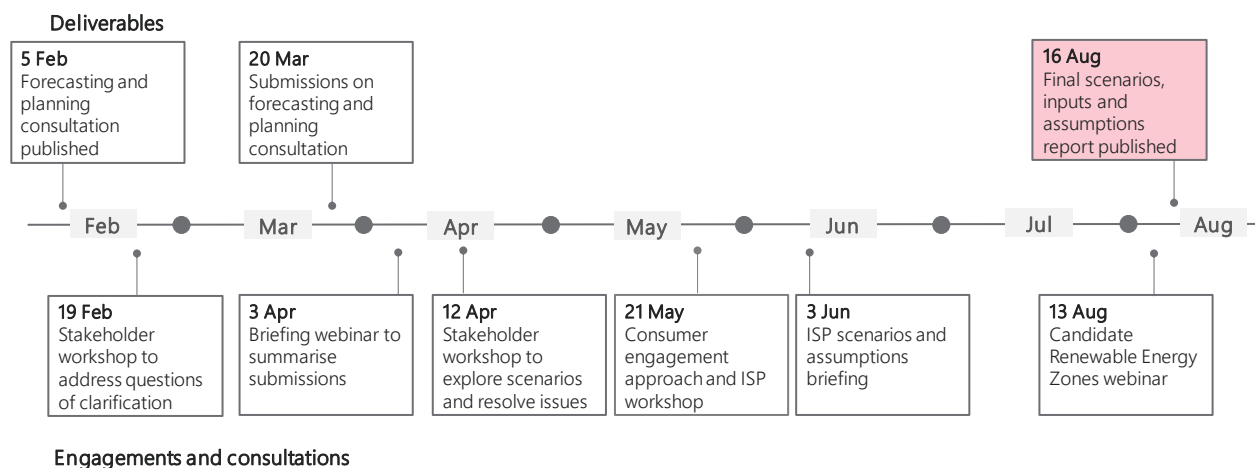

To challenge conventional thinking and ensure feedback was evaluated without unconscious bias, AEMO engaged Boston Consulting Group (BCG) to assist in stretching the range of outcomes considered, ensure there is a consistent scenario narrative behind the scenarios, and independently evaluate and cluster the feedback received. This included facilitation of a stakeholder workshop held in Sydney, whereby industry and consumer stakeholders gathered to determine the appropriate scenario narratives to adopt for the ISP, and the settings most appropriate for each of those scenarios.

AEMO gratefully acknowledges the valuable contributions from all stakeholders and BCG in this process.

## 1.2 Supplementary material

In addition to this document, AEMO has published an associated 2019 Inputs and Assumptions Workbook and the 2019 Consultation Responses Report. The 2019 Consultation Responses Report details the stakeholder feedback received during the consultation process and AEMO’s responses to these submissions.

Table 1 provides links to additional information that supplements this report, related to AEMO’s planning and forecasting inputs, assumptions, and methodologies.

**Table 1 Additional information and data sources**

Information source	Source location
2019-20 ISP Consultation submissions and responses website	<a href="https://www.aemo.com.au/Stakeholder-Consultation/Consultations/2019-Planning-and-Forecasting-Consultation">https://www.aemo.com.au/Stakeholder-Consultation/Consultations/2019-Planning-and-Forecasting-Consultation</a>
AEMO, 2019 ISP Inputs and Assumptions Workbook	<a href="https://www.aemo.com.au/-/media/Files/Electricity/NEM/Planning_and_Forecasting/Inputs-Assumptions-Methodologies/2019/2019-Input-and-Assumptions-workbook.xlsx">https://www.aemo.com.au/-/media/Files/Electricity/NEM/Planning_and_Forecasting/Inputs-Assumptions-Methodologies/2019/2019-Input-and-Assumptions-workbook.xlsx</a>

Information source	Source location
AEMO, 2018 System Strength Requirements Methodology	<a href="https://www.aemo.com.au/-/media/Files/Electricity/NEM/Security_and_Reliability/System-Security-Market-Frameworks-Review/2018/System_Strength_Requirements_Methodology_PUBLISHED.pdf">https://www.aemo.com.au/-/media/Files/Electricity/NEM/Security_and_Reliability/System-Security-Market-Frameworks-Review/2018/System_Strength_Requirements_Methodology_PUBLISHED.pdf</a>
AEMO, 2018 Inertia Requirements Methodology	<a href="https://www.aemo.com.au/-/media/Files/Electricity/NEM/Security_and_Reliability/System-Security-Market-Frameworks-Review/2018/Inertia_Requirements_Methodology_PUBLISHED.pdf">https://www.aemo.com.au/-/media/Files/Electricity/NEM/Security_and_Reliability/System-Security-Market-Frameworks-Review/2018/Inertia_Requirements_Methodology_PUBLISHED.pdf</a>
AEMO, Electricity Demand Forecasting Methodology Information Paper	<a href="https://www.aemo.com.au/-/media/Files/Electricity/NEM/Planning_and_Forecasting/NEM_ESOO/2018/Electricity-Demand-Forecasting-Methodology-Information-Paper.pdf">https://www.aemo.com.au/-/media/Files/Electricity/NEM/Planning_and_Forecasting/NEM_ESOO/2018/Electricity-Demand-Forecasting-Methodology-Information-Paper.pdf</a>
AEMO, Market Modelling Methodology Paper	<a href="https://www.aemo.com.au/-/media/Files/Electricity/NEM/Planning_and_Forecasting/Inputs-Assumptions-Methodologies/2019/Market-Modelling-Methodology-Paper.pdf">https://www.aemo.com.au/-/media/Files/Electricity/NEM/Planning_and_Forecasting/Inputs-Assumptions-Methodologies/2019/Market-Modelling-Methodology-Paper.pdf</a>
AEMO, Constraint Formulation Guidelines	<a href="http://www.aemo.com.au/-/media/Files/Electricity/NEM/Security_and_Reliability/CongestionInformation/2016/Constraint_Formulation_Guidelines_v10_1.pdf">http://www.aemo.com.au/-/media/Files/Electricity/NEM/Security_and_Reliability/CongestionInformation/2016/Constraint_Formulation_Guidelines_v10_1.pdf</a>
CSIRO, GenCost 2018: Updated projections of electricity generation technology costs	<a href="https://publications.csiro.au/rpr/download?pid=csiro:EP189502&amp;dsid=DS1">https://publications.csiro.au/rpr/download?pid=csiro:EP189502&amp;dsid=DS1</a>
GHD, 2018 AEMO Cost And Technical Parameter Review	Report: <a href="https://www.aemo.com.au/-/media/Files/Electricity/NEM/Planning_and_Forecasting/Inputs-Assumptions-Methodologies/2019/9110715-REP-A-Cost-and-Technical-Parameter-Review---Rev-4-Final.pdf">https://www.aemo.com.au/-/media/Files/Electricity/NEM/Planning_and_Forecasting/Inputs-Assumptions-Methodologies/2019/9110715-REP-A-Cost-and-Technical-Parameter-Review---Rev-4-Final.pdf</a> Databook: <a href="https://www.aemo.com.au/-/media/Files/Electricity/NEM/Planning_and_Forecasting/Inputs-Assumptions-Methodologies/2019/GHD-AEMO-revised---2018-19-Costs_and_Technical_Parameter.xlsx">https://www.aemo.com.au/-/media/Files/Electricity/NEM/Planning_and_Forecasting/Inputs-Assumptions-Methodologies/2019/GHD-AEMO-revised---2018-19-Costs_and_Technical_Parameter.xlsx</a>
Entura, 2018 Pumped Hydro Cost Modelling	<a href="https://www.aemo.com.au/-/media/Files/Electricity/NEM/Planning_and_Forecasting/Inputs-Assumptions-Methodologies/2019/Report-Pumped-Hydro-Cost-Modelling.pdf">https://www.aemo.com.au/-/media/Files/Electricity/NEM/Planning_and_Forecasting/Inputs-Assumptions-Methodologies/2019/Report-Pumped-Hydro-Cost-Modelling.pdf</a>
Core Energy, 2019 Wholesale Gas Price Outlook	Report: <a href="https://www.aemo.com.au/-/media/Files/Electricity/NEM/Planning_and_Forecasting/Inputs-Assumptions-Methodologies/2019/CORE_Delivered-Wholesale-Gas-Price-Outlook_16-January-2019.pdf">https://www.aemo.com.au/-/media/Files/Electricity/NEM/Planning_and_Forecasting/Inputs-Assumptions-Methodologies/2019/CORE_Delivered-Wholesale-Gas-Price-Outlook_16-January-2019.pdf</a> Databook: <a href="https://www.aemo.com.au/-/media/Files/Electricity/NEM/Planning_and_Forecasting/Inputs-Assumptions-Methodologies/2019/CORE-Eastern-Australia-Gas-Price-Projections-Databook_16-January-2019.xlsx">https://www.aemo.com.au/-/media/Files/Electricity/NEM/Planning_and_Forecasting/Inputs-Assumptions-Methodologies/2019/CORE-Eastern-Australia-Gas-Price-Projections-Databook_16-January-2019.xlsx</a>
Deloitte, 2019 AEMO Long-term Economic Scenario Forecasts	<a href="https://www.aemo.com.au/-/media/Files/Electricity/NEM/Planning_and_Forecasting/Inputs-Assumptions-Methodologies/2019/Long-term-economic-scenario-forecasts---Deloitte-Access-Economics.pdf">https://www.aemo.com.au/-/media/Files/Electricity/NEM/Planning_and_Forecasting/Inputs-Assumptions-Methodologies/2019/Long-term-economic-scenario-forecasts---Deloitte-Access-Economics.pdf</a>
CSIRO, 2019 Projections For Small Scale Embedded Technologies Report	<a href="https://www.aemo.com.au/-/media/Files/Electricity/NEM/Planning_and_Forecasting/Inputs-Assumptions-Methodologies/2019/2019-Projections-for-Small-Scale-Embedded-Technologies-Report-by-CSIRO.pdf">https://www.aemo.com.au/-/media/Files/Electricity/NEM/Planning_and_Forecasting/Inputs-Assumptions-Methodologies/2019/2019-Projections-for-Small-Scale-Embedded-Technologies-Report-by-CSIRO.pdf</a>
Energeia, 2019 Distributed Energy Resources and Electric Vehicle Forecasts	<a href="https://www.aemo.com.au/-/media/Files/Electricity/NEM/Planning_and_Forecasting/Inputs-Assumptions-Methodologies/2019/Distributed-Energy-Resources-and-Electric-Vehicle-Forecasts---Report-by-Energeia.pdf">https://www.aemo.com.au/-/media/Files/Electricity/NEM/Planning_and_Forecasting/Inputs-Assumptions-Methodologies/2019/Distributed-Energy-Resources-and-Electric-Vehicle-Forecasts---Report-by-Energeia.pdf</a>
Wood Mackenzie, 2019 Coal Cost Projections	Report: <a href="https://www.aemo.com.au/-/media/Files/Electricity/NEM/Planning_and_Forecasting/Inputs-Assumptions-Methodologies/2019/WoodMackenzie_AEMO_Coal_cost_projections_Approach_20190711.pdf">https://www.aemo.com.au/-/media/Files/Electricity/NEM/Planning_and_Forecasting/Inputs-Assumptions-Methodologies/2019/WoodMackenzie_AEMO_Coal_cost_projections_Approach_20190711.pdf</a> Databook: <a href="https://www.aemo.com.au/-/media/Files/Electricity/NEM/Planning_and_Forecasting/Inputs-Assumptions-Methodologies/2019/WoodMackenzie_AEMO_Delivered_cost_of_coal_20190711.xlsx">https://www.aemo.com.au/-/media/Files/Electricity/NEM/Planning_and_Forecasting/Inputs-Assumptions-Methodologies/2019/WoodMackenzie_AEMO_Delivered_cost_of_coal_20190711.xlsx</a>
Strategy Policy Research, 2019 Energy Efficiency Forecasts	<a href="https://www.aemo.com.au/-/media/Files/Electricity/NEM/Planning_and_Forecasting/Inputs-Assumptions-Methodologies/2019/StrategyPolicyResearch_2019_Energy_Efficiency_Forecasts_Final_Report.pdf">https://www.aemo.com.au/-/media/Files/Electricity/NEM/Planning_and_Forecasting/Inputs-Assumptions-Methodologies/2019/StrategyPolicyResearch_2019_Energy_Efficiency_Forecasts_Final_Report.pdf</a>

# 2. Scenarios

## 2.1 Scenario overview

Each year, AEMO assesses future planning and forecasting requirements under a range of credible scenarios over a period sufficiently long to support stakeholders' decision-making in the short, medium, and long term.

Five scenarios have been developed in collaboration with the energy industry, that vary broadly with respect to the rate of growth in grid-scale renewable generation resources, and the uptake of distributed energy resources (see Figure 3). Scenarios resulting in stronger decarbonisation and/or stronger decentralisation of the energy industry also include stronger electrification of other sectors, particularly the transport sector.

**Figure 3 Scenarios determined for examination in the 2019-20 Integrated System Plan**

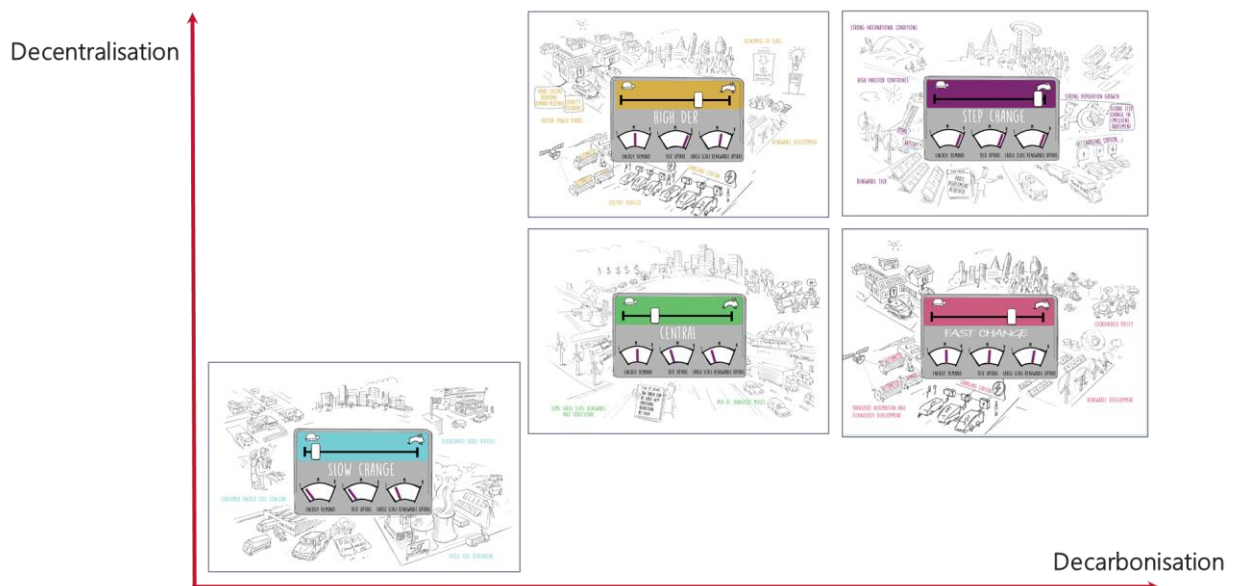

The scenarios provide a breadth of potential futures examining different roles for different elements of the industry. The scenario analysis approach will enable the identification of stationary energy industry developments to support future consumer energy needs efficiently and at lowest risk.

These scenarios investigate:

- Current transition of the energy industry, under current public policies and technology trajectories, such that consumers and investors drive future infrastructure needs (**Central**).
- Slower technology advances, lower consumer interest in directing change, and no direct policy changes beyond existing commitments (**Slow Change**).
- Consumer-led transformation of the industry, with a much faster pace of innovation and development of DER due to significant embrace from consumers (**High DER**).
- Technology-led transition of the industry, supported by policy to remove any barriers to entry, leading to a faster pace of change and cost reduction affecting large-scale providers of energy, with grid-based solutions being favoured over consumer-driven alternatives (**Fast Change**).

- Strong climate commitments and developments to support the achievement of ambitious decarbonisation objectives, in line with the aim of the Paris Agreement to limit the increase in global average temperatures to well below 2°C, supported by a mixture of technology advancements at the large scale, and consumer-led innovation (**Step Change**).

These scenarios are described in more detail in the following sections.

All five scenarios will be used in AEMO’s ISP. The 2019 ESOO for the NEM and 2020 GSOO for eastern and south-eastern Australia will also use a selection of the same scenarios.

## 2.2 Scenario narratives

### 2.2.1 Central

The Central scenario reflects a future energy system based around current government policies and best estimates of all key drivers.

This scenario represents the **current transition of the energy industry** under current policy settings and technology trajectories, where the transition from fossil fuels to renewable generation is generally led by market forces.

**Figure 4 Central scenario narrative**

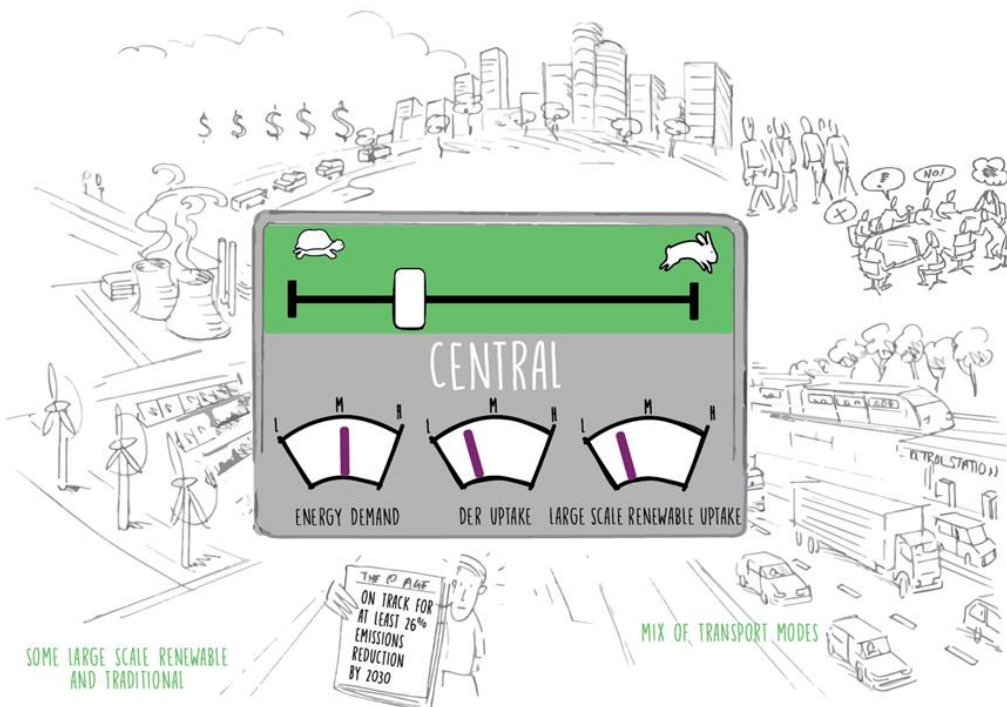

In this scenario:

- Moderate growth in the global economy is in line with current best estimates, with Australia’s long-term average growth in line with an economy in many parts of the nation slowly transitioning from being export-oriented to service-oriented. Emission reduction and energy policy settings are in line with current government policies, with focus at a federal level being on consumer costs and reliability, and regional renewable generation development and consumer investment in DER encouraged at a state level. Sectoral change beyond current policies is driven by commercial decision-making as ageing power stations close.

- Technology improvements – particularly in renewable energy and consumer technologies – are gradual, and adoption trends in new technologies such as consumer energy storage systems (ESS) and electric vehicles (EVs) are relatively slow in the next decade. Technology cost breakthroughs domestically are not expected in the short term, particularly in EVs, because vehicle prices are slow to reduce and vehicle model availability is limited. Cost parity with traditional internal-combustion engine (ICE) vehicles is not expected until about 2030, with a stronger focus on short-range vehicles (with heavier vehicles reaching cost parity approximately 10 years later). A lack of supportive policy and EV infrastructure contributes to this delayed parity with ICEs.
- Broader energy efficiency and DER development (particularly rooftop photovoltaic [PV] systems) continues, as consumers seek to invest in devices to lower their energy cost exposure, however there is no significant change to customer tariffs or additional DER incentives.
- In terms of large-scale developments, economic factors (rather than intervention policies) drive industry change. Australia remains on track to meet its current emission reduction commitment to 2030. However, global commitments to climate change and decarbonisation do not lead to strong government-led increases in commitments to meet the Paris Agreement, and as such, coal generation remains to the end of its technical life, and is not hastened by policy measures. The change affecting the stationary energy sector is evolutionary and gradual.
- In the long term, modest global carbon reduction ambitions lead to higher global and domestic temperatures and more extreme weather conditions, consistent with the IEA's latest World Energy Outlook (2018) projections<sup>12</sup>.

### Policy settings to apply in the Central Scenario

The Central scenario incorporates all government environmental and energy policies where:

- a) There is a current policy commitment with clear articulation of when and how it impacts the power system, and
- b) Any of the following criteria are met:
  - A commitment has been made in an international agreement.
  - The policy is legislated.
  - There is a regulatory obligation in relation to a policy.
  - The policy has received material funding in a State or Federal government budget.
  - The Council of Australian Governments (COAG) Energy Council, or the COAG Energy Council Senior Committee of Officials (SCO), has advised AEMO to incorporate the policy.

Given the above approach, the Central scenario includes:

- Federal emissions reduction objective of at least 26% economy-wide by 2030, with the NEM taking a pro rata share.
- Victorian Renewable Energy Target (VRET, 50% by 2030).
- Queensland Renewable Energy Target (QRET, 50% by 2030).
- New South Wales Transmission Infrastructure Strategy.
- Snowy 2.0 storage project committed.
- Current state and federal policies impacting DER and energy efficiency (EE) policies.

---

<sup>12</sup> International Energy Agency, World Energy Outlook (2018) examines the forecast energy outcomes considering the impacts of only those policies and measures that are firmly enshrined in legislation as of mid-2018. According to the IEA's "Tracking Clean Energy Progress" tracker, at <https://www.iea.org.au/tcep/>, "we are far from on track" to hitting the objectives of the Paris Agreement's well below 2°C climate goal.

## 2.2.2 Slow Change

In this scenario, economic conditions are challenging, leading to a slowdown in investment and hence transformation of the industry. Consumers and governments put more emphasis on protecting standards of living than on structural reform to the energy sector and, with less capital available, investors are slow in developing large-scale technology projects to replace existing resources.

This maintains reliance on fossil fuels well into the second half of this century. Support for local industry is high, but slow global conditions lead to challenging times for some industrial sectors.

This scenario reflects **slower technology advancements, lower consumer interest, and fewer direct policy drivers.**

Key differences to the Central scenario:

- Weaker economic and population growth.
- Slower decarbonisation of stationary energy sector and transport sector, which in turn may result in life extensions of existing generators, if economic.
- Proportionately lower decentralisation.

**Figure 5 Slow Change scenario narrative**

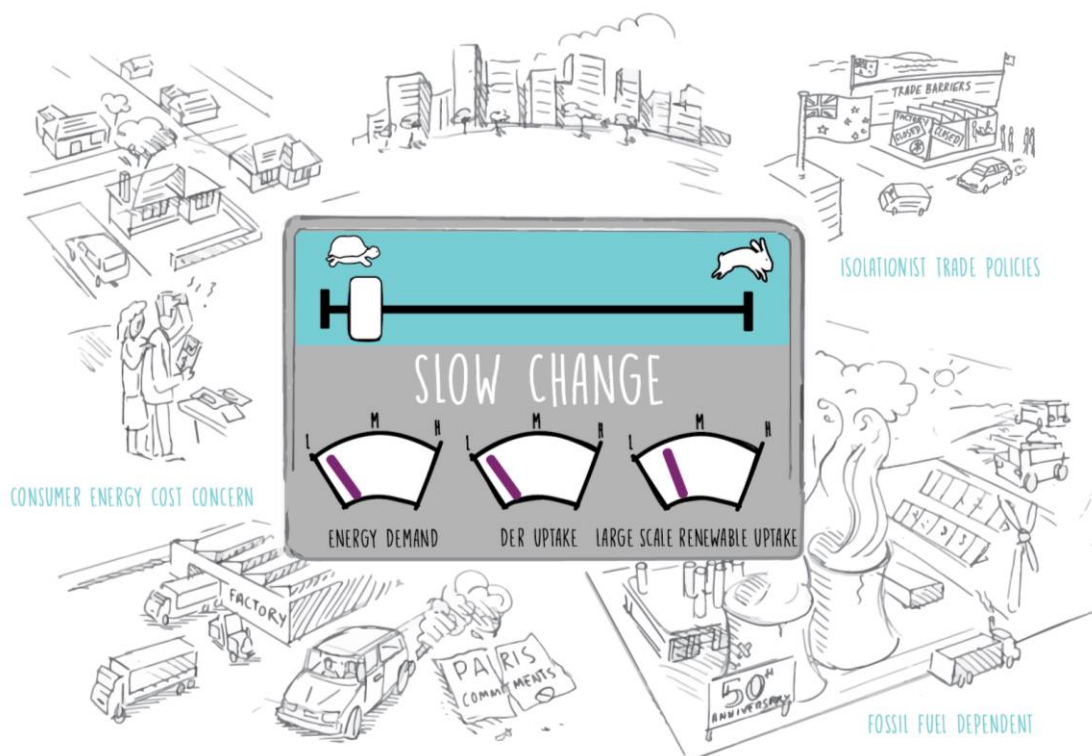

The Slow Change scenario reflects a future world with more challenging global and local economic conditions. In this scenario:

- The population growth outlook is slower, lowering broader economic growth and limiting household disposable income growth. Weak economic conditions lead to higher risk of industrial demand closures, while business and residential loads seek to lower consumption to manage bill exposure.
- With less disposable income and fewer policy settings to support DER, investment in rooftop PV, batteries, and EVs is lower relative to the Central scenario. Australia does not actively promote local EV deployment.



- Renewable generation investment slows with limited political, commercial, and social support. The generation technology transition is slower, relative to the Central scenario. While innovation in renewable generation is still expected, the rate of transition globally is slower, resulting in slower improvements in renewable generation technology costs.
- In this scenario, owners of coal generators in particular may choose to extend their asset lives, if economic, rather than invest in new resources, particularly given the higher project financing costs.
- In the long term, climate change leads to higher temperatures and more extreme weather conditions. Long-term average rainfall decline also requires more frequent operation of desalination plant.

### 2.2.3 High DER

This scenario represents a highly digital world where technology companies increase the pace of innovation in easy to use, highly interactive and engaging technologies.

This includes reduced costs and increased adoption of solar PV, ESS and EVs, with automation becoming commonplace, enabling consumers to actively control and manage their energy costs, and consumer-led preferences lead to wide spread electrification of the transport sector.

This scenario reflects **a consumer-led transformation of the energy sector**.

The key difference to the Central scenario is significantly greater decentralisation through higher DER.

**Figure 6 High DER narrative**

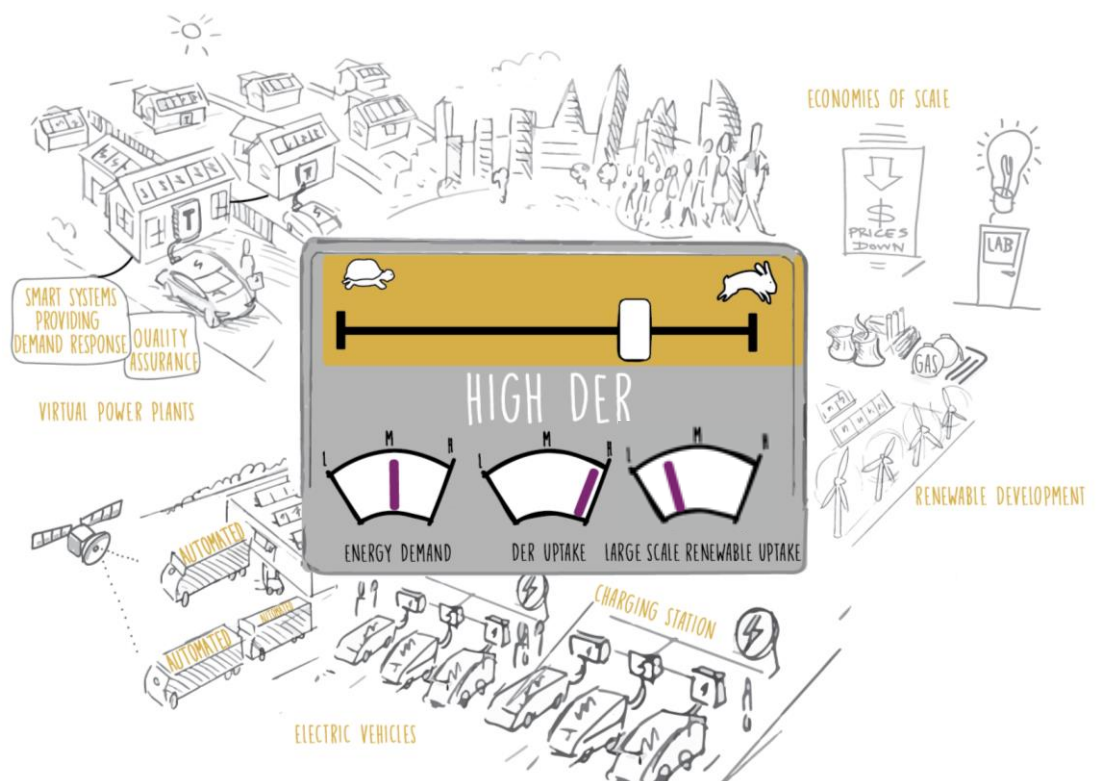

In this scenario:

- Community groups recognise that consumers, rather than large commercial or government entities, can play a strong role in the future energy mix, and consumers' actions will assist in broader decarbonisation efforts.



- Controllable home devices lead to a stronger role for at-home energy management, and the scenario has a relatively high share of consumer storage solutions, EVs, and controllable battery systems. Digital communities exist, with technological innovation increasing the ease with which energy solutions can be embraced with improved interoperability and minimal intervention.
- There is a migration away from large-scale generation developments to commercial and residential systems to help achieve decarbonisation targets.

This is a variant on the Central scenario with stronger growth in DER, and therefore has broader settings in line with that scenario.

## 2.2.4 Fast Change

This scenario includes reductions in international economic barriers, leading and delivering technological improvements and manufacturing advancements that will assist in delivering cost reductions to consumers and industry alike.

Greater digitalisation increases consumers' adoption of methods for controlling energy use and integrating transport into the energy sector. These technological improvements and cost reductions remove some of the political and social barriers to addressing climate change, and greater coordinated global emission reduction ambition is achieved.

This scenario reflects **a technology-led transition, particularly at grid scale.**

Key differences to the Central scenario:

- Faster adoption of decarbonised investments.
- Technology innovation and increased DER uptake.
- Greater EV uptake and stronger role for energy storage solutions.

**Figure 7 Fast Change narrative**

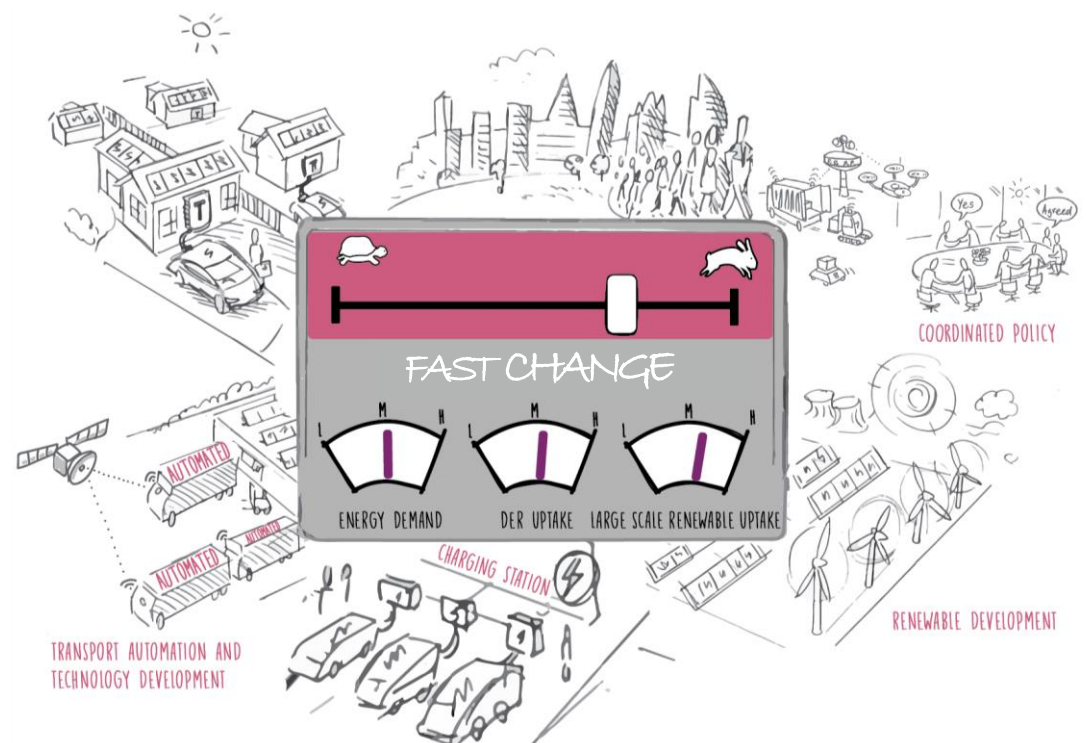

In this scenario:

- Moderate growth in the global economy is in line with current best estimates (same as Central scenario), with Australia's long-term average growth in line with an economy slowly transitioning from being export-oriented to service-oriented in many parts of the nation.
- Technology innovations lead to cost reductions across large- and small-scale technologies, as global uptake of zero and low emissions technologies is more rapid. This leads to a moderate to high degree of consumer DER penetration, with cost reductions complementing policy support that can catalyse local developments in DER including EVs (such as increased model availability and access to innovative customer tariff structures and charging stations).
- In terms of large-scale developments, strong investment focus is placed on renewable generation to meet decarbonisation goals, and some coal-fired generation retires earlier than currently expected. High uptake of renewable resources nationally results in less need for state policies to try to incentivise development of these resources locally, leading to development in areas across all NEM regions where the resource quality and transmission access is best suited.
- While stronger action on climate change is delivered sooner than in the Central scenario, developments to 2050 do not come quickly enough to limit global temperature rises to 2 degrees Celsius (°C) by 2100.

### 2.2.5 Step Change

**This scenario is new for 2019. It has been included in response to overwhelming feedback from stakeholders and industry that such a scenario would deliver valuable insights for decision-makers.**

This scenario includes a step change in response to climate change, supported by technology advancements and a coordinated cross-sector plan that efficiently and effectively tackles the adaptation challenges.

Risks associated with climate change are urgently addressed. Domestic and international action rapidly increases to achieve the objectives of the Paris Agreement.

Advancements in digital trends globally increases the role of consumer technologies to manage energy use, and technology improvements and complementary manufacturing and infrastructure developments enables greater adoption of alternative fuelled vehicles, electrifying much of that sector.

Sustainability has a very strong focus, with consumers, developers and government also supporting the need to reduce the collective energy footprint through adoption of greater EE measures.

This scenario reflects **strong direct climate action**, with a step change in approach that focuses on decarbonisation efforts.

Key differences to the Central scenario:

- Higher population and economic growth.
- Most aggressive decarbonisation goals.
- Technology innovation and increased DER uptake.
- Greater EV uptake and stronger role for energy management solutions.
- Stronger role for EE measures.

**Figure 8 Step Change narrative**

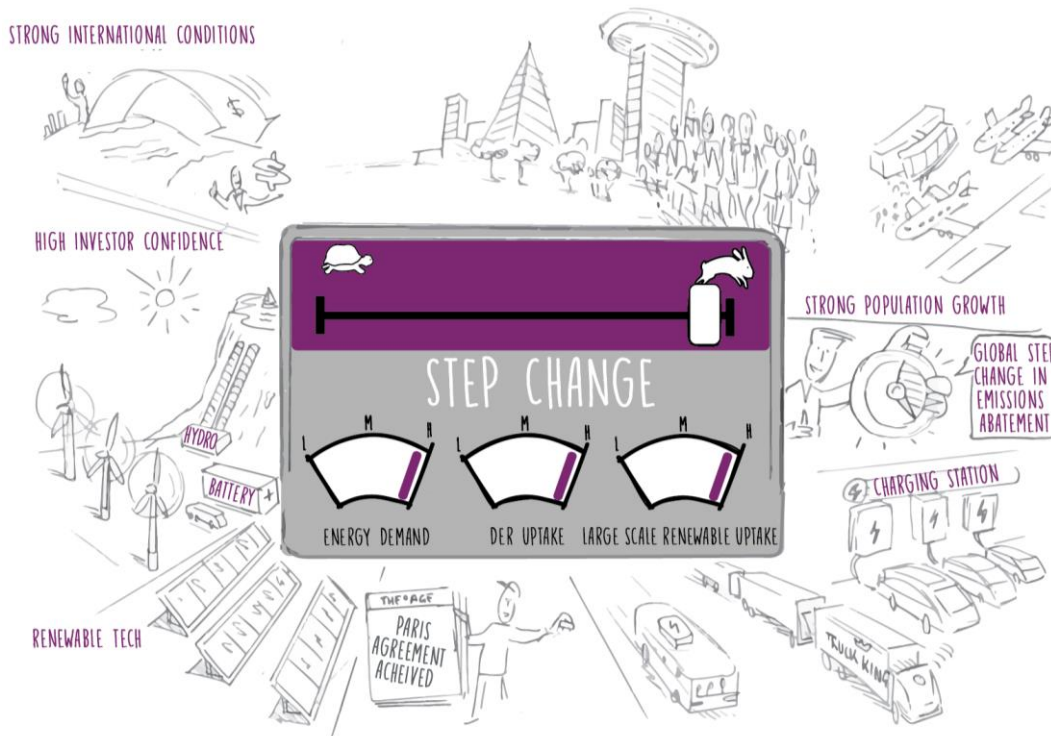

In this scenario:

- Strong climate action underpins rapid transformation of the energy sector (and broader global economy) to achieve the Paris Agreement’s goal of limiting global temperature rises to no more than 2°C, ideally less than 1.5°C.
- Australia benefits from strong population growth and economic activity from increased quality of life, migration, access to renewable resources, and a greater digital economy.
- Technology innovations lead to cost reductions across large- and small-scale technologies as global uptake of zero and low emissions technologies is prolific.
  - Greater innovation in digital trends and technology costs leads to stronger consumer energy management and DER investment, as consumers embrace their role in decarbonisation efforts and move towards digital energy (highly flexible, measurable supply sourced from multiple sites, coordinated effectively in real time through greater digital connectivity and management of ‘big data’).
  - This leads to a relatively high degree of consumer DER penetration, similar to the High DER scenario (but with a greater population base), and the electricity sector includes electrification of transportation sectors to efficiently achieve decarbonisation goals, leading to strong growth in EVs. This includes continued innovation in transport services, such as ride-sharing and autonomous vehicles, that may influence charge and discharge behaviours of the EV fleet, including vehicle-to-home discharging trends.
- In terms of large-scale developments, the scenario will exhibit the fastest rate of technology cost reductions for zero/low emissions technologies. Consistent with a step change, new policies are implemented that drive uptake of renewable generation resources well in excess of current state and federal ambitions to 2030.
- Ambitious future EE standards are set for buildings and equipment, resulting in substantial energy savings.
- Global and domestic action on climate change successfully limits global temperature rises to 1.5°C or 2 °C by 2100.

## 2.3 Key scenario parameters

For each scenario, the role of government and public policies can influence the ultimate direction and scale of action affecting the energy sector. These policy settings collectively may influence the infrastructure developed to support the consumption of energy, and each scenario will include a differing degree of policy-driven change.

The key policy settings identified for 2019-20 scenarios include national and state-driven policies:

- Existing Federal emissions reduction policy to reduce Australia’s emissions by 26% by 2030 economy-wide, with a commensurate degree of decarbonisation to be required from the electricity sector, and the NEM required to do much of this reduction (in line with the magnitude of energy consumed in the NEM relative to other smaller grids, such as those in Western Australia, Northern Territory, and regional areas).
- State renewable energy targets, including the VRET, QRET, and New South Wales Transmission Infrastructure Strategy.
- Pumped hydro initiatives – Snowy 2.0 and Battery of the Nation.
- Various policies affecting the scale and timing of EE adoption and DER penetration.

While the **Central Scenario** includes all current government policies, future possible variations in these policies are incorporated in the other scenarios to be internally consistent with the scenario narratives. Table 2 shows the settings to be applied to each scenario, and the choices are explained further below. The model representation of these policies is discussed in more detail in the Market Modelling Methodology Paper<sup>13</sup>.

**Table 2 2019 scenario policy settings**

Policy	Central	Slow Change	Fast Change	High DER	Step Change
26% reduction in emissions by 2030 (NEM)	✓	✓	✓	✓	✓
VRET – 40% by 2025	✓	✓	✓	✓	✓✓
VRET – 50% by 2030	✓	X	X	✓	✓✓
QRET – 50% by 2030	✓	X	X	✓	✓✓
NSW Transmission Infrastructure Strategy	✓	X	X	✓	✓✓
Snowy 2.0	✓	✓	✓	✓	✓
Battery of the Nation	*	*	*	*	*
Current Distributed Energy Resources policies	✓	✓	✓	✓✓	✓✓
Current Energy Efficiency policies	✓	✓	✓	✓	✓✓
NEM carbon budget	N/A	N/A	✓	N/A	✓✓

Note: ✓✓ The existing policy is included at a minimum, but volume likely to be exceeded due to carbon budget constraints.  
 \* Will not be included in the scenario as a required setting, but the project may be selected through the modelling process.

<sup>13</sup> AEMO, Market Modelling Methodology Paper, available at: [https://www.aemo.com.au/-/media/Files/Electricity/NEM/Planning\\_and\\_Forecasting/Inputs-Assumptions-Methodologies/2019/Market-Modelling-Methodology-Paper.pdf](https://www.aemo.com.au/-/media/Files/Electricity/NEM/Planning_and_Forecasting/Inputs-Assumptions-Methodologies/2019/Market-Modelling-Methodology-Paper.pdf)

The **Slow Change** scenario does not include the extended VRET and full QRET policy, as the scenario itself considers less overall emission reduction ambition with no coordinated carbon budget. Furthermore, future State governments are assumed to scale back the level of ambition pursued within their own renewable energy development targets. Renewable generation already committed under the current schemes is assumed to still be developed.

The **High DER** scenario closely represents the scenario settings of the Central Scenario, with State Governments able to support full deployment of their various renewable energy development schemes as consumers reduce the requirement from large-scale investments (and therefore the overall direct cost to State government and their citizens).

The **Fast Change** scenario focuses on greater centralised, large-scale developments located in areas that make most economic sense for investors. In this scenario, high uptake of renewable resources is expected to reduce the relative value for state policies to incentivise local renewable developments, as these developments are likely to develop naturally from the decarbonisation action nationally. As such, State governments opt not to strengthen their renewable generation aspirations, and instead revert to reliance on national objectives tied to decarbonisation goals. This is expected to lead to strong development of renewable energy across all NEM regions where the resource quality and transmission access is best suited.

The **Step Change** scenario has significant national emission abatement ambition and is likely to be supported by strong government policy at both federal and state levels. While the actual mechanisms for achieving this ambition are not defined in the scenario, it is plausible to envisage that current government policies would continue, supplemented by other incentives. In this instance, the global emission trajectory is likely to be far more binding than any other policy settings and renewable generation and DER targets are therefore expected to be well exceeded.

Table 3 consolidates all the key policy settings, demand drivers, technological improvements, investment considerations, and climatic assumptions to be applied for each of the scenarios. Details are in the 2019 Inputs and Assumptions Workbook<sup>14</sup>.

**Table 3 2019-20 scenario dimensions**

Scenario	Slow Change	Central	Fast Change	High DER	Step Change
<b>Demand drivers</b>					
<b>Economic growth and population outlook</b>	Low	Moderate	Moderate	Moderate	High
<b>EE improvement</b>	Low	Moderate	Moderate	Moderate	High
<b>Demand Side Participation</b>	Low	Moderate	Moderate	Moderate	High
<b>DER uptake</b>					
<b>Rooftop PV</b>	Low	Moderate	Moderate – High	High	High
<b>Battery storage installed capacity</b>	Low	Moderate	Moderate – High	High	High

<sup>14</sup>AEMO. 2019 Inputs and Assumptions Workbook, at [https://www.aemo.com.au/-/media/Files/Electricity/NEM/Planning\\_and\\_Forecasting/Inputs-Assumptions-Methodologies/2019/2019-Input-and-Assumptions-workbook.xlsx](https://www.aemo.com.au/-/media/Files/Electricity/NEM/Planning_and_Forecasting/Inputs-Assumptions-Methodologies/2019/2019-Input-and-Assumptions-workbook.xlsx).

Scenario	Slow Change	Central	Fast Change	High DER	Step Change
<b>Battery storage aggregation/Virtual Power Plant (VPP) deployment by 2050</b>	Existing trials do not successfully demonstrate a strong business case for VPP aggregation. Low role for energy storage aggregators and VPPs.	Moderate role for energy storage aggregators and VPPs.	Existing trials demonstrate a business case for VPP aggregation. High role for energy storage aggregators and VPPs.	Existing trials demonstrate a business case for VPP aggregation. High role for energy storage aggregators and VPPs.	Existing trials demonstrate a business case for VPP aggregation. High role for energy storage aggregators and VPPs, faster than all other scenarios.
<b>EV uptake</b>	Low	Moderate	Moderate-High	Moderate-High	High
<b>EV charging times</b>	Delayed adoption of infrastructure and tariffs to enable 'better' charging options.	Moderate adoption of infrastructure and tariffs to enable 'better' charging options.	Faster adoption of infrastructure and tariffs to enable 'better' charging options.	Faster adoption of infrastructure and tariffs to enable 'better' charging options.	Faster adoption of infrastructure and tariffs to enable 'better' charging options.
<b>Climate change (physical symptoms)</b>					
<b>Representative Concentration Pathway [RCP] (average temperature rise by 2100)<sup>A</sup></b>	RCP 8.5 (>4.5°C)	RCP 7.0 (3.0 – 4.5°C)	RCP 4.5 (2.5 – 2.7°C)	RCP 7.0 (3.0 – 4.5°C)	RCP 1.9 / 2.6 (1.4 – 1.8°C)
<b>Median Hydro inflow reduction by 2050<sup>B</sup></b>	-18%	-14%	-7%	-14%	-4%
<b>Large-scale renewable build cost trajectories<sup>C</sup></b>					
<b>Solar PV</b>	CSIRO GenCost: 4-degrees	CSIRO GenCost: 4-degrees	CSIRO GenCost: 2-degrees	CSIRO GenCost: 4-degrees	CSIRO GenCost: 2-degrees
<b>Wind</b>	Weaker reductions than CSIRO GenCost: 4-degrees	CSIRO GenCost: 4-degrees	CSIRO GenCost: 2-degrees	CSIRO GenCost: 2-degrees	Stronger reductions than CSIRO GenCost: 2-degrees
<b>Pumped hydro</b>	Weaker reductions than CSIRO GenCost: 4-degrees	CSIRO GenCost: 4-degrees	CSIRO GenCost: 2-degrees	CSIRO GenCost: 4-degrees	Stronger reductions than CSIRO GenCost: 2-degrees
<b>Battery</b>	CSIRO GenCost: 4-degrees	CSIRO GenCost: 4-degrees	CSIRO GenCost: 2-degrees	Faster relative to other technologies using CSIRO GenCost: 2-degrees scenario outcomes	Faster than CSIRO GenCost: 2-degrees, with no significant technological bias
<b>Solar thermal</b>	Weaker reductions than CSIRO GenCost: 4-degrees	CSIRO GenCost: 4-degrees	CSIRO GenCost: 2-degrees	CSIRO GenCost: 2-degrees	Stronger reductions than CSIRO GenCost: 2-degrees

Scenario	Slow Change	Central	Fast Change	High DER	Step Change
<b>Investment and retirement considerations</b>					
<b>Generator retirements</b>	Maintained at least until expected closure year, potentially extended if economic to do so.	In line with expected closure years, or earlier if economic to do so.	In line with expected closure year, or earlier if economic or driven from decarbonisation objectives.	In line with expected closure year, or earlier if economic or driven from decarbonisation objectives.	In line with expected closure year, or earlier if economic or driven from decarbonisation objectives.
<b>Project finance costs</b>	High	Moderate	Moderate	Moderate	Moderate

- A. For more information on Representative Concentration Pathways (2.6, 4.5, 6.0, 8.5) see <https://www.climatechangeinaustralia.gov.au/en/publications-library/technical-report/>. Additional RCPs (1.9, 3.4, 7.0) are emerging through work by the Intergovernmental Panel on Climate Change (IPCC) sixth assessment due to be published in 2020-21 and are developed on a comparable basis.
- B. Hydro reductions consider both rainfall reductions (global climate model [GCM] trajectories for the 'Southern Australia' supercluster in which almost all hydro facilities are located, available from [www.climatechangeinaustralia.gov.au](http://www.climatechangeinaustralia.gov.au). Median projection based on ACCESS1.0, high and low sensitivities on GFDL-ESM2M & NorESM1-M GCMs) and estimates of the effect of reduced rainfall on broader dam inflow reductions (informed by <http://www.bom.gov.au/research/projects/vicci/docs/2016/PotterEtAl2016.pdf>).
- C. AEMO large-scale renewable build cost trajectories based off CSIRO GenCost 2018: Updated projections of electricity generation technology costs, available at <https://publications.csiro.au/rpr/download?pid=csiro:EP189502&dsid=DS1>.

## 2.4 Sensitivity analysis

In any scenario analysis, it is important that scenarios be defined to adequately capture the spread of potential future worlds. Fundamentally, in scenario analysis, scenarios are used to investigate alternative futures, whereas sensitivities are designed to validate the significance of key assumptions within a given future.

For the 2019-20 ISP, AEMO will use sensitivities to determine how resilient the development plan is to variations in key assumptions.

Table 4 outlines AEMO's current list of likely sensitivities that AEMO will explore at a minimum. The list includes consideration of policies which are less certain, but reasonably likely. These sensitivities will focus on identifying the robustness of the whole-of-system plan. Time permitting, AEMO may add to this list, depending on the outcomes of the modelling being undertaken.

**Table 4 Identified 2019-20 ISP sensitivities**

Sensitivity	Purpose
<b>Delay in timing of Snowy 2.0</b>	To test the resilience of the development plan if the Snowy 2.0 scheme was delayed unexpectedly, without investor confidence to address the gap in development that this may create.
<b>Early retirement of existing generation</b>	To test the resilience of the power system to a major reduction in brown coal power station generation much earlier than submitted closure dates, without sufficient notice or capacity to develop efficient generation alternatives. (Such a reduction could be realised ahead of permanent retirements, including mothballing on a seasonal basis or reduced station output through rotating long-term maintenance on parts of the station or stations.)
<b>Battery of the Nation (BOTN)</b>	Committing the development of the BOTN project and accompanying Marinus Link to complement the development of the Snowy 2.0 project. A phased Marinus Link will be assumed with 600 MW in 2025-26 and a further 600 MW in 2027-28.
<b>De-commitment of QRET</b>	Excluding the QRET policy to test the regional development of renewable resources in Queensland, and the impact of this on transmission development recommendations.



# 3. Inputs and assumptions

The key data required for AEMO's supply forecasting models is:

- Demand forecasts, comprising the expected energy consumption, maximum and minimum demand expectations, and the degree of avoided grid-consumed energy due to DER penetration or EE measures.
- Energy policy settings.
- Technical and cost data of existing, planned, and candidate generators, storages, and transmission paths.

The following sections outline the key inputs and assumptions AEMO will adopt in its 2019-20 planning and forecasting publications. For each of these assumptions, the 2019 Inputs and Assumptions Workbook<sup>15</sup> provides additional details.

## 3.1 Key components for forecasting energy consumption

AEMO updates its projections of energy consumption annually. This is done for electricity as part of the ESOO, and for gas as part of the GSOO. This process includes significant stakeholder consultation, industry engagement (via surveys), consultant data and recommendations, and AEMO's internal forecasting of each sector and sub-sector affecting energy consumption and peak demands.

The 2019-20 ISP will use the demand and energy forecasts produced for the 2019 ESOO<sup>16</sup> and 2019 GSOO<sup>17</sup>. These forecasts have involved extensive consultation with industry pre-publication (and after publication, in the case of the GSOO), and during the drafting of the forecasts (in the case of the ESOO), via AEMO's Forecasting Reference Group and industry workshops.

Key components in the forecasts include:

- DER forecasts of:
  - Rooftop PV.
  - Customer ESS.
  - EV uptake and charging behaviours.
  - The role of ESS aggregation and virtual power plants (VPPs).
- Economic and population growth drivers.
- EE forecasts.
- Fuel switching.
- Outlook for large industrial loads and liquefied natural gas (LNG) exports.

### 3.1.1 Customer distributed energy resources

In recognition of the uncertainty in, and importance of DER, AEMO engaged two consultants<sup>18</sup> to provide detailed assessments of the potential role of DER, as well as the charge and discharge behaviours of these

---

<sup>15</sup>AEMO. 2019 Inputs and Assumptions Workbook, at [https://www.aemo.com.au/-/media/Files/Electricity/NEM/Planning\\_and\\_Forecasting/Inputs-Assumptions-Methodologies/2019/2019-Input-and-Assumptions-workbook.xlsx](https://www.aemo.com.au/-/media/Files/Electricity/NEM/Planning_and_Forecasting/Inputs-Assumptions-Methodologies/2019/2019-Input-and-Assumptions-workbook.xlsx).

<sup>16</sup>AEMO, NEM ESOO, at <https://www.aemo.com.au/Electricity/National-Electricity-Market-NEM/Planning-and-forecasting/NEM-Electricity-Statement-of-Opportunities>.

<sup>17</sup>AEMO, 2019, GSOO, at [https://www.aemo.com.au/-/media/Files/Gas/National\\_Planning\\_and\\_Forecasting/GSOO/2019/2019-GSOO-report.pdf](https://www.aemo.com.au/-/media/Files/Gas/National_Planning_and_Forecasting/GSOO/2019/2019-GSOO-report.pdf).

<sup>18</sup>AEMO engaged CSIRO and Energeia to perform this work. Both consultant reports are available under "Supporting materials" at <https://www.aemo.com.au/Electricity/National-Electricity-Market-NEM/Planning-and-forecasting/Inputs-Assumptions-and-Methodologies>.

devices, across the forecast scenarios. Energeia and CSIRO each applied their own methodologies to forecast each DER element while having a common set of assumptions and scenario themes.

In the case of EVs, AEMO has also held several cross-sector workshops to test assumptions on uptake, charging and discharging profiles<sup>19</sup>.

This has enriched AEMO’s understanding of drivers of future DER uptake and provided AEMO capacity to select the most appropriate mix of DER trajectories to match the scenario narratives for the ISP.

Depending on the scenario narrative, the forecasts consider varying degrees of:

- Usage of EVs:
  - Current driving behaviour and future driving behaviour (trip duration, trip distance, time of day).
  - Current tariff uptake.
  - Different charging behaviours and time of day profiles across multiple vehicle types, influenced by future tariff adoption and the cost of charging infrastructure (such as public fast charging and at-home chargers), along with the effects of integration with other DER (for example, home PV systems).
- Usage of ESS:
  - Charging/discharging profiles for the business and residential sector considering the availability and incentives provided through storage aggregators as well as standard and time-of-use/demand tariffs.
  - The impact of ride-sharing and opportunities for growth in autonomous vehicles affecting vehicle adoption rates and usage.
  - The potential for vehicle-to-home discharging at peak times with available stored capacity.

The level of DER uptake projected for the 2019 ESOO, and to be used in the 2019-20 ISP, is shown in the following figures on a NEM-wide scale.

**Figure 9 Forecast effective capacity of rooftop PV installations (MW)**

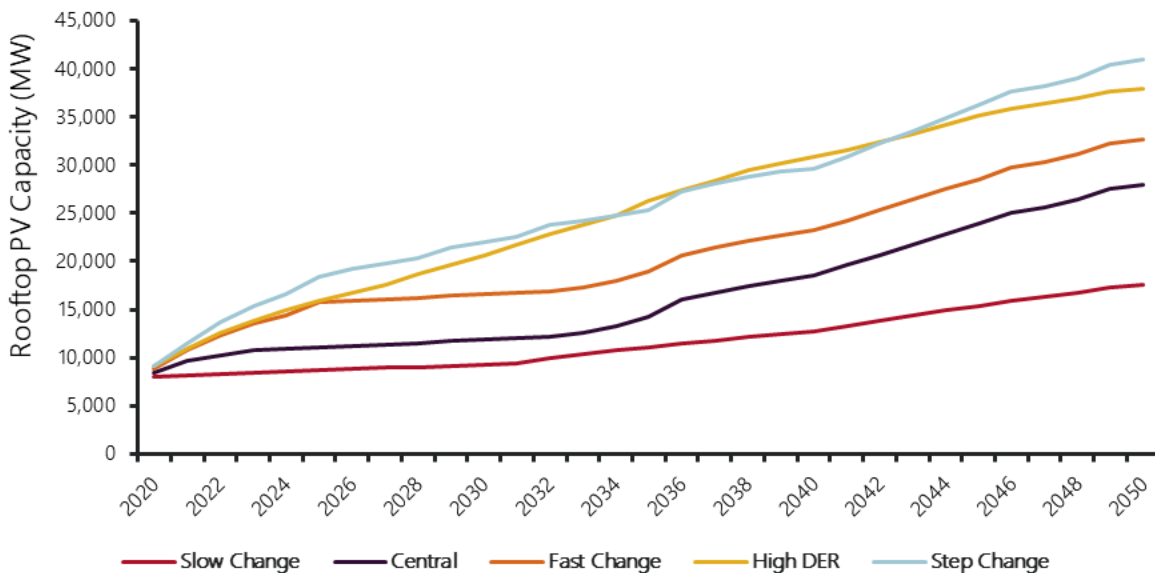

<sup>19</sup> Participants from the energy sector were AEMO, AGL, ARENA, Ausgrid, AusNet, Citipower, ElectraNet, Energeia, Energy Australia, Evie Networks, Jet Charge, Jemena, Powercor, Powerlink, and United Energy; transport sector participants were Infrastructure Victoria and Vicroads; and other attendees were CSIRO, the Victorian Department of Environment, Land, Water and Planning, the New South Wales Department of Planning and Environment, and NHP Electrical Engineering Products.

**Figure 10 Forecast effective capacity of installed consumer battery capacity (megawatt hours [MWh])**

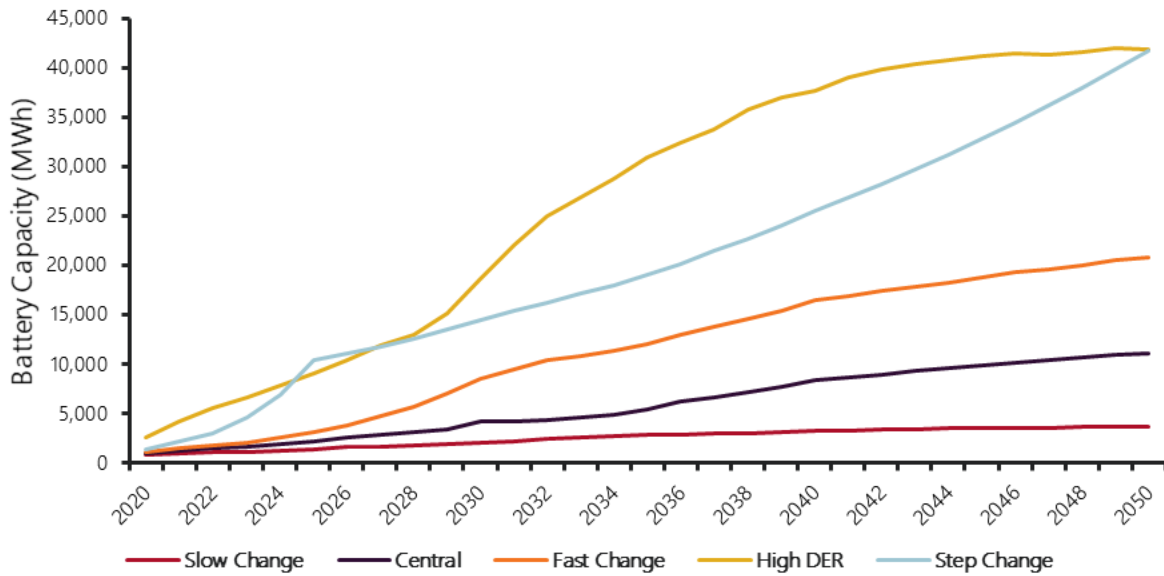

**Figure 11 Forecast electricity consumption from electric vehicles (MWh)**

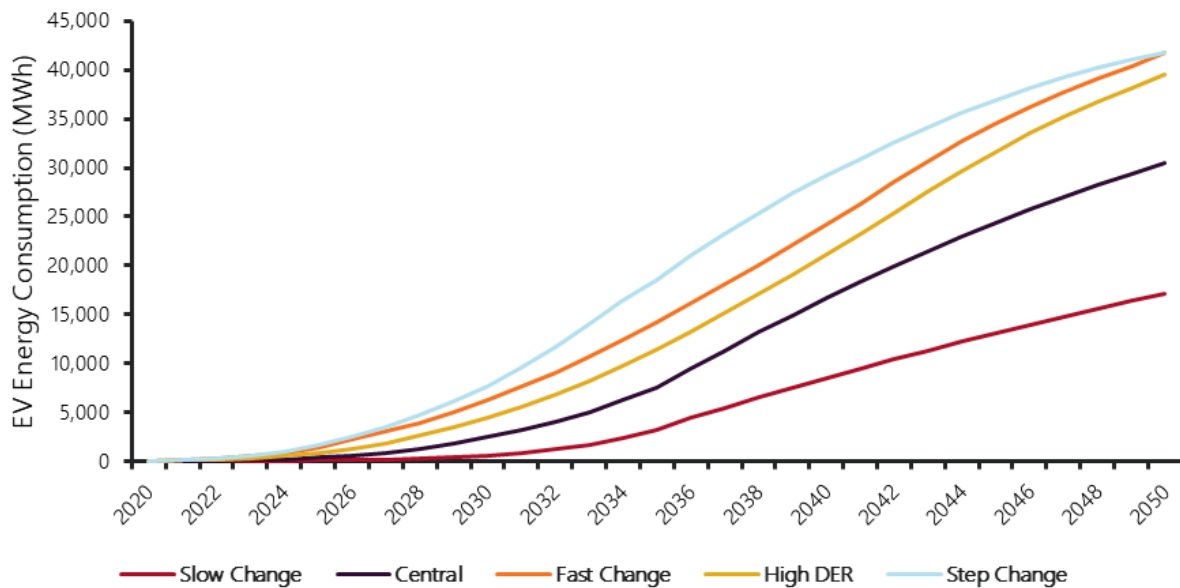

### 3.1.2 Energy storage system aggregation and virtual power plants

A VPP broadly refers to an aggregation of consumer DER, coordinated using software and communications technology to deliver services that have traditionally been provided by conventional power plants. AEMO is collaborating across the industry to establish VPP demonstrations to identify the role VPPs could have in providing reliability, security, and grid services.

While VPPs are currently on a small scale in the NEM, several large-scale VPP projects and government subsidies to support VPP-capable systems have recently been announced. These projects have targets that equate to up to 700 megawatts (MW) of VPP-enabled storage systems to be capable in the NEM by 2022<sup>20</sup>.

<sup>20</sup> AEMO, 2018, NEM VPP Demonstrations Program, at <https://www.aemo.com.au/-/media/Files/Electricity/NEM/DER/2018/NEM-VPP-Demonstrations-program.pdf>.

The degree of further development of VPP-activated aggregated storages (as opposed to simply technologically capable of aggregation) varies by scenario, as shown in Figure 12 below:

- In the Slow Change scenario, the degree of VPP development is very low, with that scenario not successfully demonstrating customer acceptance or the VPP business case from current trials leading to a low role for aggregation.
- In other scenarios, VPP development is more significant, with the Step Change, High DER, and Fast Change scenarios all having over 15 gigawatt hours (GWh) of distributed, controllable battery storage by 2050.
- The High DER scenario (with the greatest focus on distributed, consumer-led developments) provides maximum flexibility of VPP use, with approximately double the power discharge capacity of the other two by 2050. This increased capacity would allow more flexible operation of the VPP fleet. Aggregators could rapidly discharge the stored energy in shorter bursts, potentially lopping the most extreme peaks for a short time (one hour), or operating to spread the available stored energy over a longer duration (two to four hours), similar to the Fast Change and Step Change scenarios.

**Figure 12 Coordinated battery capacity in terms of operating as VPPs**

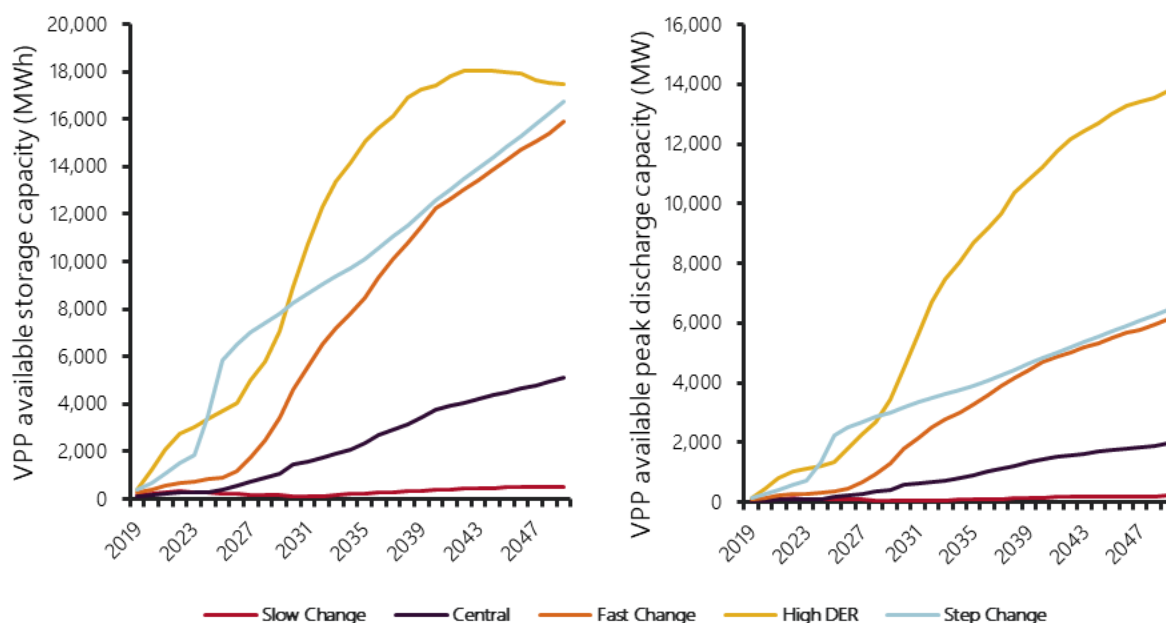

AEMO models aggregated distributed storage systems as operating to meet system peaks (rather than household demand). These VPPs are assumed to operate with day-ahead foresight and optimise charge and discharge behaviours to minimise total system costs. These batteries could be operated to offset the risk of unserved energy. Currently, no limitation is placed on the frequency of aggregators to interact with these VPP-enabled ESS devices.

Non-aggregated battery systems installed by homeowners are assumed to operate to minimise costs for supply paid for that household. This is much more passive behaviour, and may not discharge optimally with market requirements, instead following default battery algorithms to discharge when stored energy is available to meet demand that exceeds on-site generation through rooftop PV systems.

Household and utility-scale batteries are currently modelled with 2.6 kilowatt hours (kWh)/kilowatts (kW) energy to power ratio, meaning that from fully charged the battery could provide over two hours of supply if discharging at full capacity (or longer if discharging at less than full capacity). The actual discharge profile depends on the state of charge of the battery, which relies on forecast production from rooftop PV generators, and the customer's household load profile.

### 3.1.3 Economic and population forecasts

AEMO commissioned Deloitte Access Economics to develop forecasts<sup>21</sup> of the economic outlook underpinning AEMO’s demand forecasts for each scenario. In Deloitte’s central forecasts, the short-term prospects for the economy remain robust, with all states and territories expected to experience continued economic growth. In the long run, key determinants of growth are population and productivity. While the Australian population is expected to continue to grow, the rate of growth is expected to slow, due to the population ageing. On the other hand, continuing technological innovation is expected to maintain stable productivity growth over time, in line with long run historical trends.

As a means of testing the influence population and economic growth will have on the transition facing the energy sector, AEMO applies lower and higher estimates of these Central forecasts to the scenarios, consistent with the scenario narratives:

- Deloitte’s weak growth outlook sees countries shying away from international engagement, resulting in greater inefficiency and lower productivity. Global and domestic economic growth decline is observed, relative to the Central scenario, with lower productivity, trade, and migration.
- In contrast, Deloitte’s stronger growth outlook is based on the successful implementation of long-term structural reforms to increase trade in goods and services as well as movement of people across borders. The forecast impact of these reforms is an increase in trade, productivity, and migration.

Deloitte’s outlooks assume broad-based declines/increases in economic growth across states and territories, which are symmetric and linear in nature between scenarios.

AEMO has applied Deloitte’s weak growth outlook to the Slow Change scenario, and Deloitte’s strong growth outlook to the Step Change scenario (with the emphasis in this scenario being on stronger population growth). All other scenarios adopt Deloitte’s central outlooks.

**Figure 13 Forecast economic growth in Gross State Product of NEM regions**



### 3.1.4 Energy efficiency forecasts

The EE forecasts calculate the amount of avoided energy consumption as a result of policy-induced and other voluntary measures that aim to reduce energy demand and/or greenhouse gas emissions.

<sup>21</sup> Deloitte, 2019, Long term economic scenario forecasts, at [https://www.aemo.com.au/-/media/Files/Electricity/NEM/Planning\\_and\\_Forecasting/Inputs-Assumptions-Methodologies/2019/Long-term-economic-scenario-forecasts---Deloitte-Access-Economics.pdf](https://www.aemo.com.au/-/media/Files/Electricity/NEM/Planning_and_Forecasting/Inputs-Assumptions-Methodologies/2019/Long-term-economic-scenario-forecasts---Deloitte-Access-Economics.pdf).

In 2019, the EE forecasts consider the following measures:

- Building code energy performance standards.
- National Australian Built Environment Rating System (NABERS) and Commercial Building Disclosure program.
- State-based schemes such as New South Wales' Energy Savings Scheme, the Victorian Energy Upgrades Program, and the South Australian Retailer Energy Efficiency Scheme.
- Equipment Energy Efficiency (E3)/Greenhouse and Energy Minimum Standards (GEMS).
- Former Federal Government programs, including the Household Insulation Program for the Residential sector and the Energy Efficiency Opportunities Program for the Manufacturing sector.

The economic and population growth settings, and scenario dimensions, determine the extent to which energy savings are applied to each of the scenarios:

- The Slow Change and Central scenarios include current and committed EE policy measures, under low and moderate economic and population growth settings, respectively.
- The High DER and Fast Change scenarios use the same EE forecast as the Central scenario.
- The Step Change scenario considers higher EE uptake by incorporating additional measures related to future building codes and GEMS, in addition to current and committed measures. The magnitude of these additional measures is amplified by the higher economic and population growth settings inherent within the Step Change scenario.

**Figure 14 Forecast energy savings from energy efficiency measures impacting business and residential sectors**

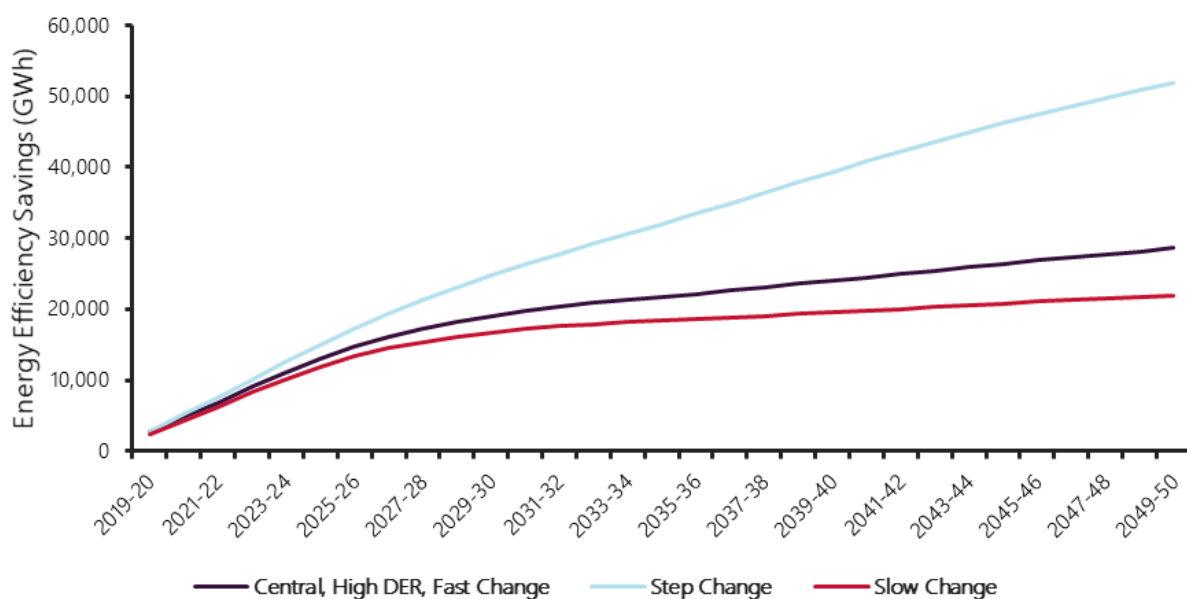

### 3.1.5 Applying historical climatic conditions to forecast years

AEMO's models apply a consistent methodology to consider the weather conditions which influence energy consumption (including maximum demand and minimum demand), network ratings, DER generation, and large-scale renewable generation profiles (including wind and solar generation). These weather conditions also capture water inflows affecting hydro availability.

Time-sequential 'traces' are used to provide an hourly reflection of these relevant inputs. These traces reflect the historical patterns observed in up to nine previous financial years, or 'reference years'. AEMO applies a

consistent methodology to develop these reference year traces so weather patterns and correlations affecting each of these inputs are maintained, and all market modelling is internally consistent.

Future physical symptoms of climate change, specifically increases in extreme temperatures and reductions in average rainfall, are then superimposed on these reference years going forward in time (see Section A2.3 of AEMO's Demand Forecasting Methodology Information Paper<sup>22</sup> for more details of how changes in extreme temperature are captured in the demand forecasts).

### 3.1.6 Demand side participation

AEMO's forecast maximum demand excludes demand side participation (DSP), meaning it represents forecast maximum demand in the absence of any DSP occurring. Instead, AEMO incorporates a forecast of DSP into its modelling as a 'supply' resource available to meet forecast demand.

AEMO forecasts DSP using two key sources of information:

- Loads that may respond to price signals, as reported to AEMO through the DSP information collection process and supplemented by other lists maintained by AEMO.
- Reliability DSP programs targeting smaller customers where reported capacity and response estimates of the DSP programs are used or derived.

AEMO forecasts other non-scheduled generation (ONSG) contributions to peak demand separately, and these contributions are included in the maximum demand forecast. Therefore, NEM DSP values exclude contributions from these generators, to avoid double counting.

The methodology used to estimate NEM DSP is split into two main categories:

- Market-driven responses:
  - Customers are grouped into programs (groups can include single or multiple customers as necessary). Historical responses to market events (defined by wholesale price bands) are estimated through subtraction of a modelled baseline demand from actual demand. The median (most likely) responses are grouped by NEM region and adopted as the DSP response for each price band.
- Reliability responses:
  - Customers that reduce demand in response to reliability event triggers (network reliability programs but excluding any Reliability and Emergency Reserve Trader (RERT) actions or directions from AEMO) are derived from reported values or agreement conditions and, where possible, verified against actual responses using metering data.

For long-term planning studies like the ISP, the DSP projection is prepared based on current levels and adopting a level to be met by the end of the outlook period. The level is defined as the magnitude of DSP relative to maximum demand and linearly interpolated between the beginning and ends of the outlook period. The level reflects scenario assumptions and region-specific features where necessary.

A review of international literature and reports of demand response (DR) potential (primarily in the US and Europe) indicated that the adopted (high) level of 8.5% of maximum demand (also adopted for the 2018 ISP) is a reasonable upper estimate for growth in DSP. Further findings of the review indicated:

- Expanding existing best practice DSP, focusing on commercial and industrial programs, could feasibly achieve DSP potential of 9% of maximum demand, given some United States markets where DR programs are advanced are already seeing participation levels between 2% and 10% of peak demand<sup>23,24</sup>.

---

<sup>22</sup> AEMO Demand Forecasting Methodology Information Paper, at [https://www.aemo.com.au/-/media/Files/Stakeholder\\_Consultation/Consultations/NEM-Consultations/2019/Reliability-Forecasting-Methodology/Electricity-Demand-Forecasting-Methodology-Information-Paper---draft-2019.pdf](https://www.aemo.com.au/-/media/Files/Stakeholder_Consultation/Consultations/NEM-Consultations/2019/Reliability-Forecasting-Methodology/Electricity-Demand-Forecasting-Methodology-Information-Paper---draft-2019.pdf).

<sup>23</sup> FERC, 2009 Assessment of Demand Response and Advanced Metering, 2009, at <https://www.ferc.gov/legal/staff-reports/sep-09-demand-response.pdf>.

<sup>24</sup> FERC, 2018 Assessment of Demand Response and Advanced Metering, 2018, at <https://www.ferc.gov/legal/staff-reports/2018/DR-AM-Report2018.pdf>.



- Reported current DR potential, in markets where DSP is advanced, can range from 3% to 12%<sup>25</sup>.
- DSP potential in European countries is estimated to be between 7.5% and 10%, with some outliers outside this range, and one estimate suggesting the level was 9.4% for 34 countries represented<sup>26,27,28</sup>.
- Large (five- or eight-fold) differences between current active DSP and future potential DSP may exist<sup>29</sup>.
- Market structures (wholesale price market or capacity market) and DSP policy design (conditions on participation) play a role in incentivising or creating barriers to DSP.

The ISP forecast DSP also includes an estimated response from 2019-20 from Queensland coal seam gas (CSG) facilities. This response is excluded from the 2019 ESOO because it is not committed, nor has it been historically observed. Its inclusion in the ISP reflects AEMO's assumption that established CSG facilities now have the capability to reduce demand if incentivised, and that this reduction would be triggered when wholesale prices reach the market price cap (under lack of reserve conditions).

Further information on DSP analysis and forecasting will be published on AEMO's website in 2019.

## 3.2 Key policy settings

AEMO will incorporate all current policy settings in the Central scenario, and test alternative futures in the other scenarios through the inclusion of NEM carbon budgets and policy variations. Policies which are less certain, but reasonably likely, may be modelled as sensitivities.

Section 2.3 outlines the policy settings to apply in each scenario. The following sections outline in greater detail the various policy settings that will apply, and explains how the carbon budgets are derived.

### 3.2.1 Emissions reductions and climate change

Each scenario narrative is associated with a particular atmospheric greenhouse gas concentration, as outlined in Table 3 (in Section 2.3).

In the Central scenario, AEMO will apply existing national and state emissions and renewable energy policies (such as Australia's existing commitment to a Paris Agreement target of 26% emissions reduction by 2030, and state policies such as the VRET and QRET). The Central scenario will also apply the expected generator closure dates supplied to AEMO. These settings are expected to drive ongoing emission reductions.

In the Slow Change scenario, AEMO will also apply Australia's existing 26% Paris Agreement emissions reduction target by 2030, while state policies such as the VRET and QRET are not extended from currently legislated levels. The Slow Change scenario will allow life extensions of coal generators for 10 years beyond current closure dates if the system value of these extensions is greater than the refurbishment cost.

In other scenarios, AEMO will apply carbon budgets broadly consistent with the degree of decarbonisation assumed for each scenario. These cumulative budgets will require the electricity sector to constrain emissions to a specified volume between 2020 and 2050. Scenarios with lower levels of emissions will have stricter budgets, with the trajectory of emissions reductions over time being determined within the model to meet the carbon budget as efficiently as possible. Carbon budgets will be achieved by allowing the model to retire and replace emission-intensive plant (black and brown coal generators) with large-scale renewable generation or low emissions technologies (gas-powered generation [GPG]).

<sup>25</sup> ERCOT Annual Report of Demand Response (2019), at <http://www.ercot.com/services/programs/load>.

<sup>26</sup> SIA Partners, Demand Response: A study of its potential in Europe, February 2015, at <http://energy.sia-partners.com/demand-response-study-its-potential-europe>.

<sup>27</sup> Gils, H. C., Economic potential for future demand response in Germany – Modelling approach and case study, Applied Energy 162 (2016) 401-415.

<sup>28</sup> Gils, H. C. Assessment of the theoretical demand response potential in Europe, Energy 67 (2014) 1-18.

<sup>29</sup> SEDC & RAP, Slides presented on Potential of Demand Response in Europe, Workshop on Demand Participation in Electricity Markets and Demand Response: Regulatory Framework and Business Models, 2017, at [https://www.raonline.org/wp-content/uploads/2017/11/rap\\_sedc\\_rosenow\\_thies\\_fsr\\_slides\\_2017\\_oct.pdf](https://www.raonline.org/wp-content/uploads/2017/11/rap_sedc_rosenow_thies_fsr_slides_2017_oct.pdf).

The use of carbon budgets allows AEMO’s modelling to identify and apply optimal timings of generator closures to achieve the emissions reduction objectives of each scenario. The optimal timings are an outcome of the modelling approach, which balances the cost and availability of alternative generation technologies and the emissions intensity of available options, as well as the operational envelope of existing generators.

The 2050 carbon budgets will be modelled as a hard constraint that must be achieved. The assumed carbon budgets for each scenario are shown in Figure 15 below. The figure re-affirms the approach for the Central and Slow Change scenarios (which will not apply explicit carbon budgets), and also displays the cumulative emissions (to 2040, rather than 2050) associated with the 2018 ISP outcomes, demonstrating that the 2019-20 ISP scenarios will capture stronger emission reduction scenarios compared to the 2018 scenarios.

The actual year-on-year emission trajectories will be determined within the modelling and will be shared, along with other preliminary model outcomes, later in 2019. For some scenarios, the carbon budgets may not be binding, with market- or policy-driven outcomes driving a faster pace of change. To determine future NEM emission production, AEMO applies the generator efficiency and emissions intensity of each generator and new entrant technology, as estimated by ACIL Allen in 2016<sup>30</sup>, and reviewed and confirmed most recently by GHD<sup>31</sup>. No carbon price will be used in any scenario.

**Figure 15 Cumulative NEM electricity sector emissions to 2050 that will be input as carbon budgets**

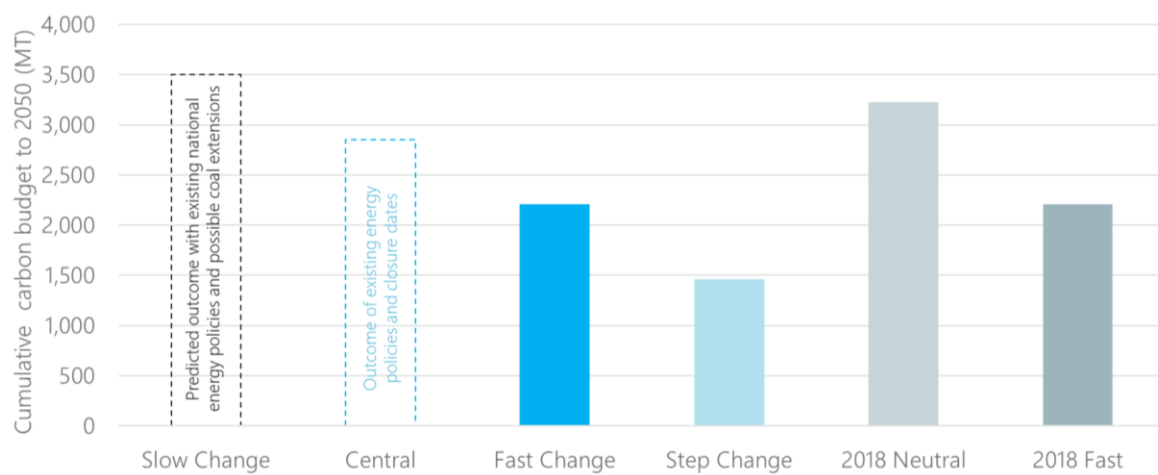

The specific carbon budget assumptions for each scenario have been developed as follows:

- Each scenario has been allocated a “Representative Concentration Pathway” (RCP) that represents the global greenhouse gas concentration trajectory consistent with the scenario narrative. The RCPs have been developed by climate scientists to describe possible pathways for atmospheric greenhouse gas concentrations, and the associated climate change impacts. Development of “Shared Socio-economic Pathways” (SSP) has broadened the future climate scenarios, providing narratives around global emissions drivers, mitigative capacity and adaptive capacities that may result in particular RCPs. The RCP/SSP framework is designed to be complementary, and AEMO has considered it appropriate to continue to focus on the RCPs selected, thereby maximising flexibility in scenario specification.
- The global trajectories have been translated to Australian trajectories using methodologies broadly consistent with the modified contraction and convergence approach suggested by the Climate Change

<sup>30</sup> ACIL Allen, Emissions Factors: Assumptions Update, 2016, at [https://www.aemo.com.au/-/media/Files/Electricity/NEM/Planning\\_and\\_Forecasting/NTNDP/2016/Data\\_Sources/ACIL-ALLEN---AEMO-Emissions-Factors-20160511.pdf](https://www.aemo.com.au/-/media/Files/Electricity/NEM/Planning_and_Forecasting/NTNDP/2016/Data_Sources/ACIL-ALLEN---AEMO-Emissions-Factors-20160511.pdf).

<sup>31</sup> GHD, 2018 AEMO costs and technical parameter review, under “Supporting materials”, at <https://www.aemo.com.au/Electricity/National-Electricity-Market-NEM/Planning-and-forecasting/Inputs-Assumptions-and-Methodologies>.

Authority<sup>32</sup> for use in setting Australian emissions budgets. This method considers an equitable allocation of responsibility between countries with global convergence towards equal per person rights.

- A NEM budget was then developed based on the Australian budget and relevant scenario narrative. For example, the NEM may lead the Australian budget in scenarios with aggressive decarbonisation goals and may remain parallel in others. The budget informing the Step Change scenario is broadly consistent with the Climate Change Authority’s Special review electricity research report<sup>33</sup>.

While some scenarios include high levels of emission reductions, they do not reach zero NEM emissions by 2050. It is assumed that some emissions will be required for system black start and synchronous and peaking support capabilities, and/or that emissions reductions will become more cost-effective in other sectors of the economy.

Despite emissions not reaching zero, the Step Change scenario is considered appropriate for either RCP2.6 or RCP1.9 global outcomes. In this scenario, the electricity sector has led national emissions reduction efforts to the degree that remaining variation must be driven by other sectors of the economy.

The physical symptoms of climate change will be varied across the scenarios to reflect the scenario narratives. For example, the timing and magnitude of action in the Step Change scenario will be far greater than in the Slow Change scenario, and in response will result in less climate change. In the context of the energy sector, Australian-specific climate information on regional changes in average and extreme temperatures and long-term average rainfall has been estimated through close collaboration with CSIRO and the Bureau of Meteorology as part of the Electricity Sector Climate Information (ESCI) project, sponsored by the Australian Government<sup>34</sup>. Figure 16 shows the global temperature change expected for the four atmospheric greenhouse gas concentrations (RCP2.6-RCP8.5) applied across the scenarios<sup>35</sup>.

**Figure 16 Climate pathways modelled across ISP scenarios**

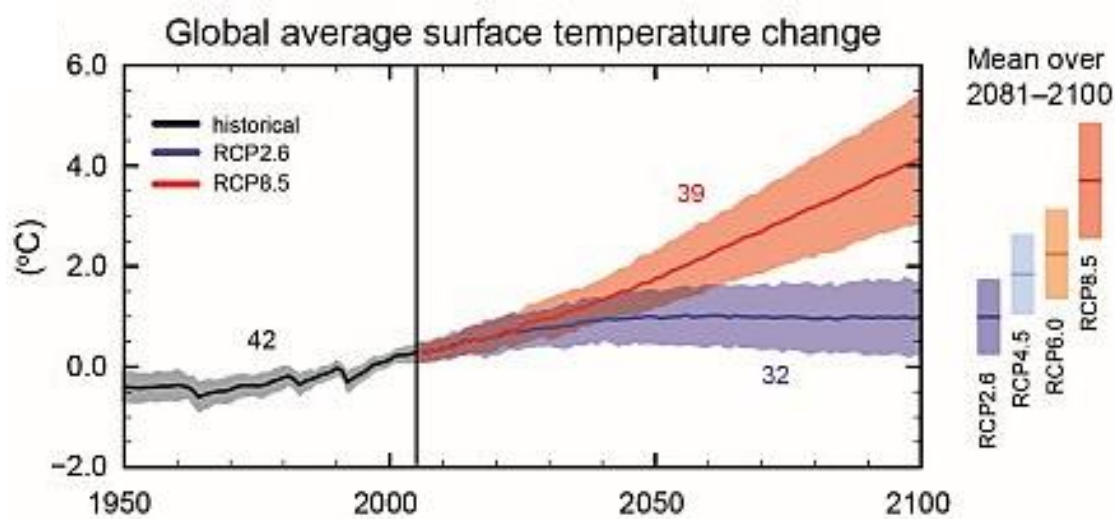

### 3.2.2 Renewable energy targets

#### Large-scale Renewable Energy Target (LRET)

The national LRET provides a form of stimulus to renewable energy development.

<sup>32</sup> Climate Change Authority, Targets and Progress review, at <http://climatechangeauthority.gov.au/reviews/targets-and-progress-review-3> (Appendix C).

<sup>33</sup> Climate Change Authority, 2016. Special review electricity research report, at [www.climatechangeauthority.gov.au/reviews/special-review/special-review-electricity-research-report](http://www.climatechangeauthority.gov.au/reviews/special-review/special-review-electricity-research-report).

<sup>34</sup> See <http://www.environment.gov.au/climate-change/adaptation>.

<sup>35</sup> Global climate change projections, at <https://www.climatechangeinaustralia.gov.au/en/climate-campus/global-climate-change/global-projections/>.

In modelling the LRET, AEMO takes account of the legislated target (33,000 GWh by 2020), as well as commitments to purchase Large-scale Generation Certificates (LGCs) from the GreenPower scheme and Australian Capital Territory (ACT) reverse auction programs.

AEMO applies the national LRET in proportion to the energy consumption in NEM versus non-NEM energy regions, resulting in approximately 84% of the LRET target being targeted for development in the NEM.

### **Victorian Renewable Energy Target (VRET)**

The VRET mandates 25% of the region's generation be sourced from renewable sources by 2020, 40% by 2025, and 50% by 2030. The target is measured against Victorian generation, including renewable DER. Currently in the region there are over 7,300 MW of committed or proposed wind generation projects, and approximately 2,400 MW of committed or proposed solar generation projects<sup>36</sup>.

### **Queensland Renewable Energy Target (QRET)**

The Queensland Government has committed to a 50% renewable energy target by 2030. The target is measured against Queensland energy consumption, including renewable DER. Currently in the region there are over 1,800 MW of committed or proposed wind generation projects, and almost 13,800 MW of committed or proposed solar generation projects (over 50% of all committed or proposed solar generation projects across the NEM)<sup>37</sup>.

### **New South Wales Transmission Infrastructure Strategy**

The New South Wales Transmission Infrastructure Strategy seeks to increase the ability for the industry to invest in infrastructure projects by focusing on enabling transmission developments and increasing access to low-cost generation sources. The Strategy will seek to boost the level of interconnection between New South Wales and Queensland, and Victoria and South Australia, and improve access to the Snowy Hydro scheme. The ISP will ensure the Strategy is accurately reflected with regard to transmission development. It will also prioritise renewable energy zone (REZ) developments in the Central West, South West, and New England areas of New South Wales.

### **Distributed Energy Resources policies**

Various policies exist across NEM jurisdictions to support uptake of DER, including:

- South Australia – Home Battery Scheme<sup>38</sup>.
- Victoria – Solar Homes Package<sup>39</sup>.
- New South Wales – Clean Energy Initiatives<sup>40</sup>.
- Queensland – solar battery rebates<sup>41</sup>.
- Trial programs to integrate VPPs and explore how a network of small-scale PV and batteries can be collectively controlled and fed into the grid<sup>42</sup>.

AEMO has incorporated each of these schemes in the DER uptake and behavioural analysis performed within the 2019 demand forecasts.

---

<sup>36</sup> AEMO 8 August 2019 Generation Information release, at <https://www.aemo.com.au/Electricity/National-Electricity-Market-NEM/Planning-and-forecasting/Generation-information>.

<sup>37</sup> AEMO 8 August 2019 Generation Information release, at <https://www.aemo.com.au/Electricity/National-Electricity-Market-NEM/Planning-and-forecasting/Generation-information>.

<sup>38</sup> Details at <https://homebatteryscheme.sa.gov.au/>.

<sup>39</sup> Details at <https://www.solar.vic.gov.au/>.

<sup>40</sup> Details at <https://energy.nsw.gov.au/renewables/clean-energy-initiatives>.

<sup>41</sup> Details at <https://www.qld.gov.au/community/cost-of-living-support/concessions/energy-concessions/solar-battery-rebate>.

<sup>42</sup> Further details on AEMO's VPP integration trials are at <https://www.aemo.com.au/Electricity/National-Electricity-Market-NEM/DER-program/Virtual-Power-Plant-Demonstrations>.

## 3.3 Key technical and economic settings affecting energy supply

### 3.3.1 Generators and storage data

AEMO's online Generation Information page<sup>43</sup> provides data on existing and committed generators and storage projects (size, location, capacities, seasonal ratings, and expected closure years). This information will underpin these elements of the generation fleet applied to the 2019-20 ISP and be used to cross-check assumed technology mixes and limits in each REZ. Generation development in the near term will be informed by development interest across REZs, with committed developments captured explicitly.

The cost and performance of new generation technologies has been updated to reflect the most current pricing and estimates of future cost and performance data of new generation technologies.

AEMO has collaborated with the Clean Energy Council (CEC), CSIRO, GHD, and other stakeholders through the GenCost project<sup>44</sup> to develop these estimates of future generation costs and other resource parameters. This information will be updated annually, and includes:

- Fixed and variable operating and maintenance costs.
- Thermal efficiency factors.
- Emissions factors.
- Unit auxiliary loads.
- Capital costs for new generation developments.

For the 2019-20 ISP, AEMO will use data for generators and storage technologies presented in the 2019 Inputs and Assumptions Workbook that incorporates data from these sources.

### 3.3.2 Technology build costs

To capture the most current pricing for a more reliable future cost and performance estimation process, AEMO collaborated with GHD and CSIRO to update new entrant costs and technical parameters across a selection of generation and storage technologies. According to GHD, these current cost estimates have an expected accuracy range of -20% to +50% (costs used for concept screening), or -15% to +30% (costs used for feasibility studies), depending on the level of definition of the generating plant and information available.

For the 2019-20 planning and forecasting publications, AEMO will use cost projections to build new generation technologies developed by CSIRO's Global and Local Learning Model (GALLM), which has been the subject of extensively consultation with stakeholders within the GenCost 2018 project.

One of the most notable updates of this review is providing the technology costs for a range of geographic regions across Australia, and a broader range of storage capacity to energy ratios.

#### **Candidate generation technology options**

GHD and CSIRO produced projected build costs for a range of new generation technologies. For 2019-20 modelling, a filtered list of technologies – selected from those provided by GHD and CSIRO, and guided by stakeholder feedback – will be considered, based on technology maturity, resource availability, and energy policy settings.

Table 5 below presents the list of generation technologies to be included within AEMO's ISP models, for consideration in each scenario.

---

<sup>43</sup> Data on existing and committed generators is given in each regional spreadsheet on the Generation Information page, at <https://www.aemo.com.au/Electricity/National-Electricity-Market-NEM/Planning-and-forecasting/Generation-information>.

<sup>44</sup> CSIRO, 2018, GenCost 2018: Updated projections of electricity generation technology costs, at <https://publications.csiro.au/rpr/download?pid=csiro:EP189502&dsid=DS1>.

**Table 5 Candidate generation technology options**

Technologies to be available in the 2019-20 ISP	Commentary
Combined cycle gas turbines (CCGT)	
Open cycle gas turbines (OCGT)	
Supercritical black coal	Given the market need for flexible plant to firm low-cost renewable generation, new coal generation would be highly unlikely in any scenario with emissions abatement objectives, particularly given the long-life nature of any new coal investment.
Supercritical brown coal	
Synchronous condenser	
Biomass (wood) – electricity only	
Solar photovoltaics – single axis tracking	
Solar thermal central receiver with storage	
Wind – onshore	
Wind – offshore	Victorian offshore locations (off the Gippsland REZ) will be included, given expanded data sets obtained from DNV-GL.
Battery storage	AEMO will include 2- and 4-hour variants of battery storages in its models. No geographical or geological limits will apply to available battery capacity.
Pumped hydro energy storage (PHES)	AEMO will include 6-hour, 12-hour, 24-hour, and 48-hour variants of PHES.

From the table above, excluded technologies include:

- Nuclear generation – nuclear generation is excluded, as currently Section 140A of the Environment Protection and Biodiversity Conservation Act 1999<sup>45</sup> prohibits the development of nuclear installations.
- Carbon capture and storage – currently no domestic carbon capture and storage technologies are in operation, and there is insufficient data available that would allow complete modelling of the generation, capture, transmission, and storage of emissions using dedicated pipeline infrastructure to new CO<sub>2</sub> storage facilities. Should the technology advance further, with sufficiently granular data becoming available, then it may be possible to include in future ISPs.
- Reciprocating engines – the technical differences between extreme peaking generation (open cycle gas turbine [OCGT], aero-derivatives, diesels, and reciprocating engines) will not be capturable in the ISP generation models. As such, to simplify the modelling task, only OCGTs will be considered. However, any of several extreme peaking thermal generation options may be appropriate alternatives that will go beyond the modelling scope of the ISP but may be considered qualitatively, particularly with regard to ancillary services these various technologies may provide to maintain system security.
- Geothermal technologies – geothermal technologies are considered too costly and too distant from existing transmission networks to be considered a bulk generation technology option in any REZ, nor have they been successfully commercialised in Australia. There may be targeted applications of geothermal technologies suitable for the NEM, but they will be excluded from the ISP modelling in 2019-20.
- Solar PV fixed flat plate (FFP) and dual-axis tracking (DAT) technologies – AEMO acknowledges that the best solar configuration may vary for each individual project. Given current cost assumptions, single-axis tracking (SAT) generally may present a greater value solution within the Capacity Outlook models of the ISP. AEMO notes that the 8 August 2019 Generation Information update shows that approximately 60% of

<sup>45</sup> Australian Government, Environment Protection and Biodiversity Conservation Act 1999, at <https://www.legislation.gov.au/Details/C2012C00248>.



current proposed projects are proposed with a SAT configuration, rather than FFP or DAT. Given this broad preference and the relative cost advantage, and considering the relatively small difference in expected generation profiles of each technology, AEMO will model all future solar developments with a SAT configuration. This exclusion is not anticipated to have any material impact on the benefits of the ISP's development plans from a whole-of-system perspective.

- Biomass – AEMO's models will include a single representation of biomass. Given the cross-functional value provided by cogeneration, it will not be feasible to consider cogeneration options broadly within the ISP.
- Tidal/wave technologies – this is not sufficiently advanced or economic to be included in the modelling.

### Build cost scenarios

CSIRO GALLM build cost projections are a function of global and local technology deployment. As the global technology deployment depends on the global climate policy, CSIRO GALLM build cost projections are given for two scenarios, termed "4-degrees" and "2-degrees" to describe the global climate policy goal. These form the basis for the technology cost reductions assumed in each scenario, as outlined in Table 3. Note that these costs only represent the capital cost component of a new power station. To understand the delivered cost of energy for each technology, a number of additional factors need to be considered, for example, fuel costs (if applicable) and capacity factors.

Figure 17 presents CSIRO GALLM build cost projections for selected technologies chosen for construction in Melbourne for the 4-degrees scenario, excluding the connection costs.

**Figure 17 Build cost projection for selected technologies for 4-degrees scenario (\$/kW)**

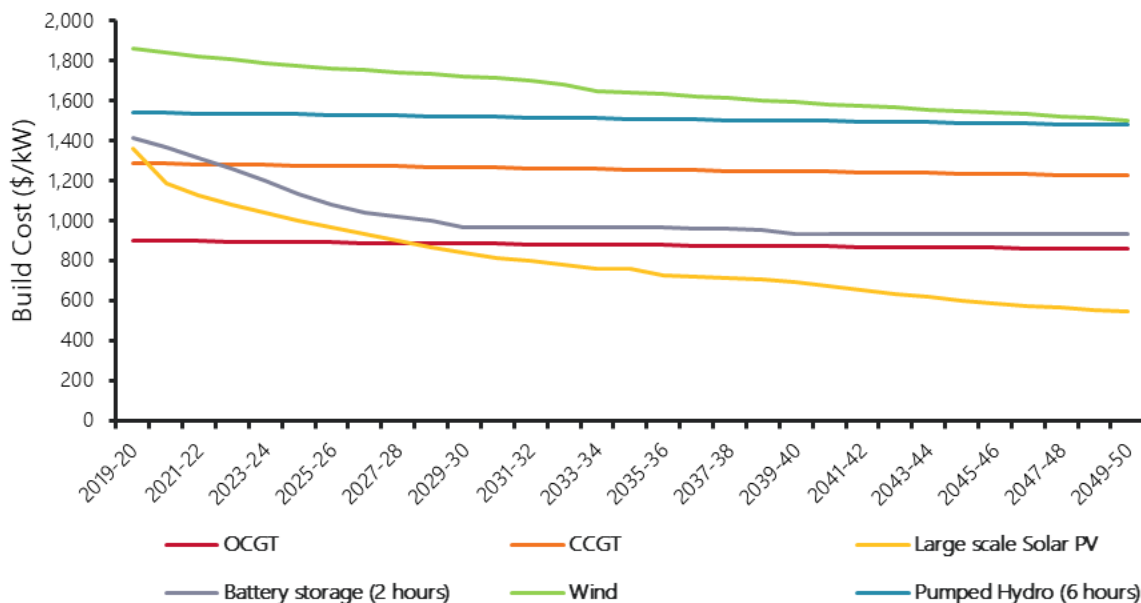

As Figure 17 shows, large-scale solar PV is projected to experience a long-term rapid decline in costs, while, in contrast, the projected rate of capital cost reduction of wind is relatively modest. While the capital cost of wind generation technology may not be improving as fast as solar PV, the levelised cost of wind is projected to fall. This can be attributed to larger wind turbines being deployed, which are able to generate power at lower wind speeds, resulting in higher capacity factors

### Scenario-specific technology build costs

AEMO has aligned scenario technology costs to one of two cost trajectories developed in the GenCost 2018 report. ISP scenarios will bring forward or delay some or all technology cost improvements in some scenarios



on the basis that, according to scenario narratives, global technology uptake will be slower or faster than CSIRO's expectations:

- The Slow Change scenario will delay build costs reductions for several technologies.
- The Fast Change and Step Change scenarios will bring forward cost reductions for several technologies.

Key technologies affected by this cost dispersion include wind, solar PV, and solar thermal generators. Specific cost projections for each scenario and technology combination are provided in the 2019 Inputs and Assumptions Workbook.

**Figure 18 Generation technology costs across the scenarios**

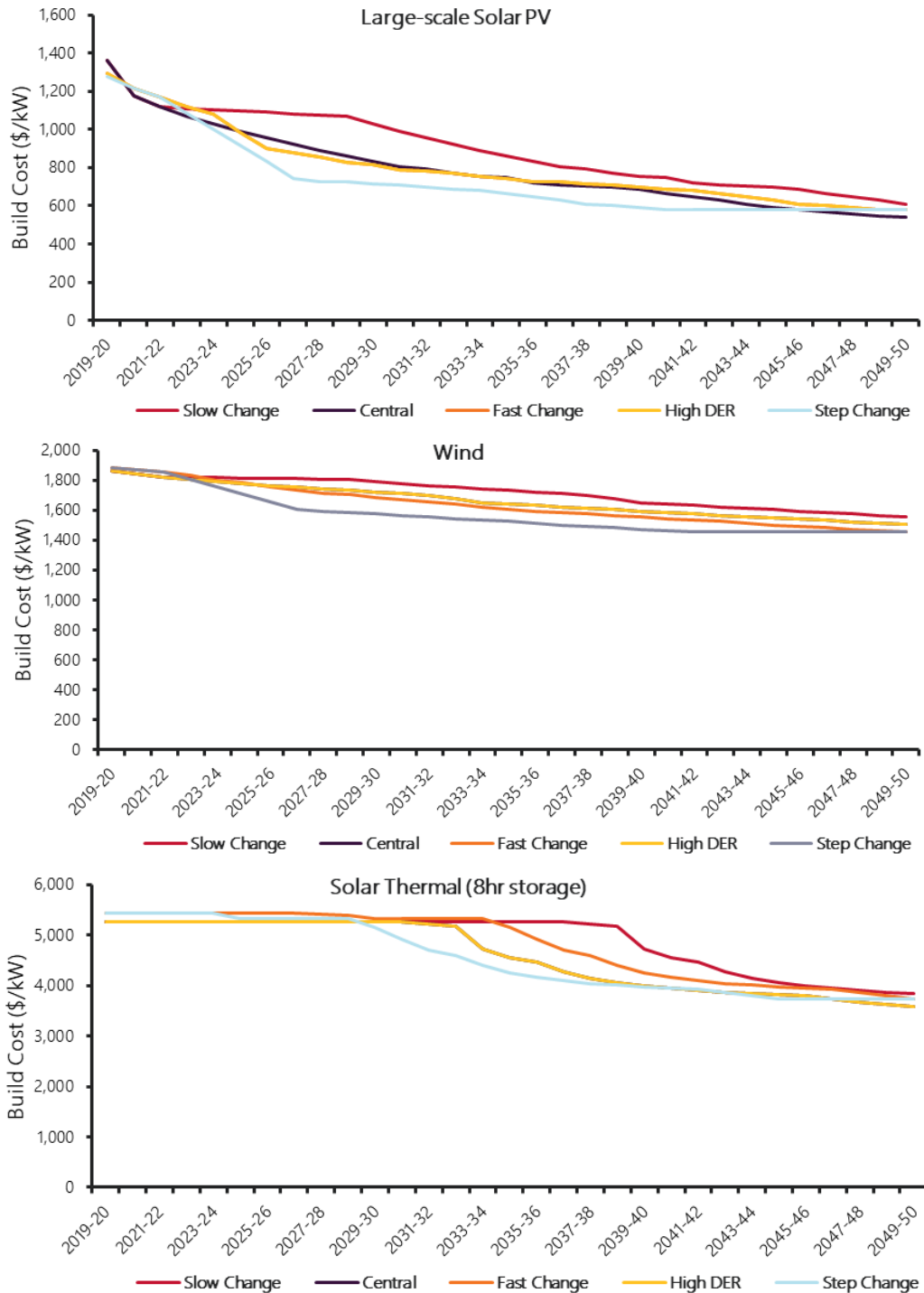

## Locational cost factors

Developing new generation can be a labour- and resource-intensive process. Access to specialised labour and appropriate infrastructure to deliver and install components to site can have a sizable impact on the total cost of delivering a project. Access to ports, roads, and rail, and regional labour cost differences, all contribute to locational variances of technologies, ignoring localised environmental/geological/social drivers.

AEMO's consultants GHD estimated locational cost adjustment factors that may be applied to technologies to capture the known drivers of cost differences. Figure 19 presents the overlaid regional cost factor map prepared by GHD over the REZ map. Three cost regions are presented – low, medium, and high – and summarise locational multiplicative scalars that should apply between developments of equivalent type but across different locations. Detailed values are provided in AEMO's 2019 Inputs and Assumptions Workbook.

Because the relativity between locational cost groupings differs based on development cost weightings, the figure is to be interpreted with consideration of Table 6, which shows the relativity of the regional costs between locational cost groupings, per region. For ease of use, the 2019 Inputs and Assumptions Workbook provides this for each technology, given development cost shares.

Cost projections to build new generation technologies developed by GHD are the overnight costs for construction in Melbourne. To calculate the capital costs of these technologies elsewhere in Australia, the locational cost factors provide a multiplicative scaler to the respective generation development costs.

**Table 6 NEM locational cost factors**

Region	Grouping	Equipment costs	Fuel connection costs	Cost of land and development	Installation costs	O&M costs
Victoria	Low	1.00	1.00	1.00	1.00	1.00
	Medium	1.03	1.03	1.00	1.03	1.03
	High	1.05	1.05	1.00	1.05	1.05
Queensland	Low	1.00	1.05	1.00	1.10	1.07
	Medium	1.05	1.16	1.00	1.27	1.20
	High	1.10	1.27	1.00	1.44	1.34
New South Wales	Low	1.00	1.09	1.00	1.18	1.13
	Medium	1.05	1.17	1.00	1.30	1.22
	High	1.10	1.26	1.00	1.42	1.32
South Australia	Low	1.00	1.01	1.00	1.02	1.01
	Medium	1.05	1.11	1.00	1.17	1.13
	High	1.10	1.21	1.00	1.32	1.25
Tasmania	Low	1.00	1.04	1.00	1.07	1.05
	Medium	1.05	1.11	1.00	1.18	1.14
	High	1.10	1.19	1.00	1.29	1.23

Figure 19 Locational cost map

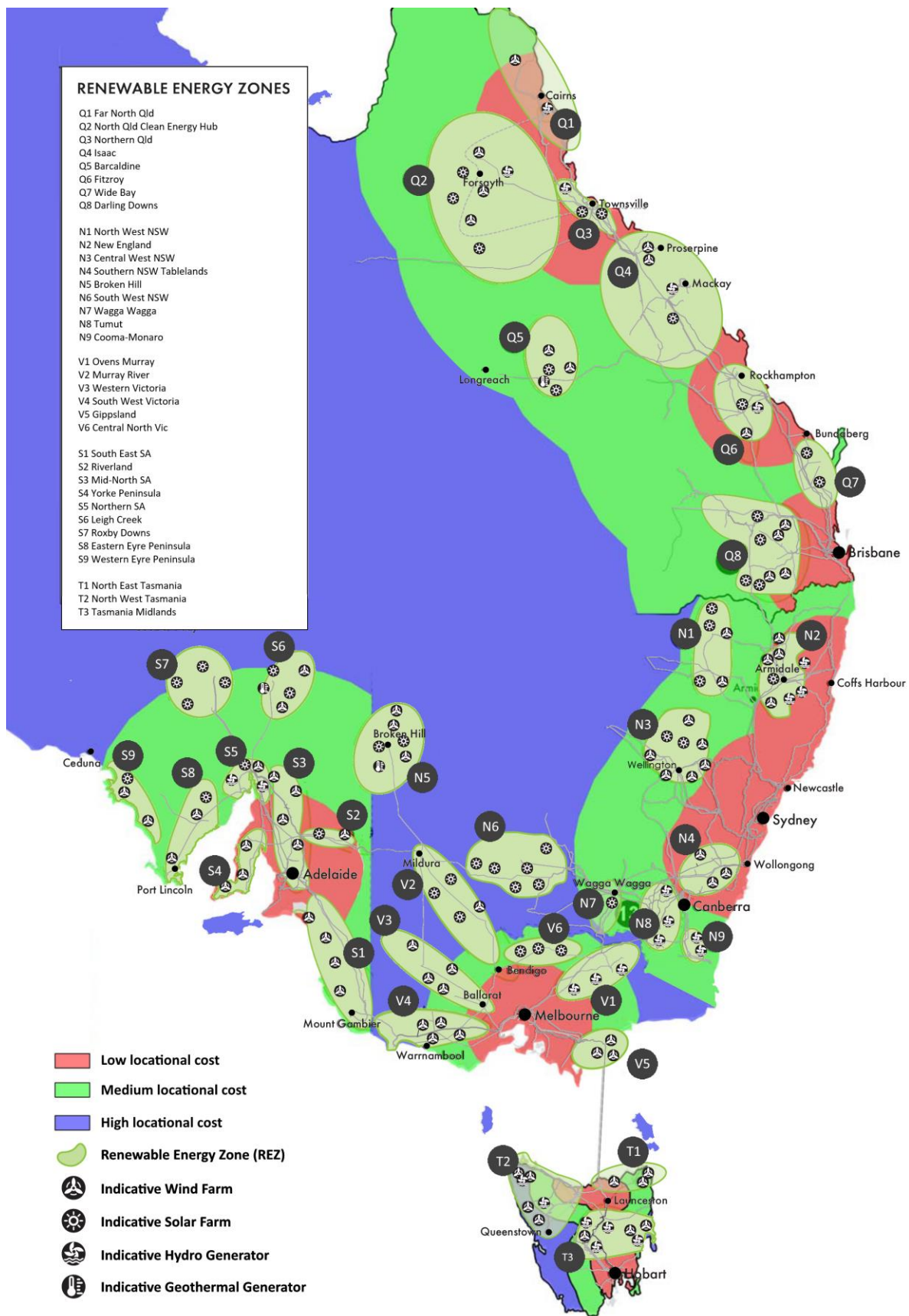

## Wind build costs, site quality deterioration, and efficiency improvements

CSIRO has forecast modest capital cost reductions for wind technologies and improvements in wind turbine efficiencies with larger turbines. This technology improvement is expected to lead to more energy output for the same installed capacity, lowering the investment cost per unit of energy (\$ per megawatt hour [MWh]). To reflect this trend in AEMO's models, transformation of the CSIRO inputs is required.

The capital cost of wind technology is adjusted down to effectively mirror the \$/MWh cost reductions from turbine efficiency improvements. AEMO considers this a reasonable approach (applying cost reductions and maintaining static renewable energy profiles), given the development of renewable technologies such as wind is targeted largely to provide energy, rather than peak capacity, and therefore accurate representation of the cost per unit of energy is more appropriate than per unit of capacity. This approach provides an appropriate balance of supply modelling complexity and accuracy.

## Modelling offshore wind

For the 2019-20 ISP, AEMO will include offshore wind in its modelling, using expanded data provided by DNV-GL that extends 10 km offshore in some locations of the NEM. AEMO will allow offshore wind in the Gippsland REZ in Victoria for the 2019-20 ISP.

### 3.3.3 Storage technology modelling

AEMO has increased the breadth of storage options to be modelled in the 2019-20 ISP. Storage expansion candidates in each region will include pumped hydro energy storage (PHES) as well as large-scale batteries, concentrated solar thermal (CST), and DER.

AEMO captures the location of storage developments through power flow modelling and in detailed constraint equations. Expansion models consider storage technologies on a regional basis only.

## Hydro generator modelling

AEMO models each of the large-scale hydro schemes using inflow data for each generator, or aggregates some run-of-river generators, as explained in AEMO's Market Modelling Methodology Paper<sup>46</sup>. For the 2019-20 ISP, AEMO has obtained data direct from existing large-scale hydro operators which improves the variance of expected hydro generation outputs across multiple weather years.

AEMO has liaised with stakeholders to enhance the representation of key existing and new hydro schemes and improve the modelling representation to better capture these dynamics. This collaboration has allowed AEMO to incorporate a more realistic representation of the Snowy Hydro and Hydro Tasmania schemes, addressing previous limitations by explicitly and discretely modelling inflows, reservoir sizes, pumping and generation efficiency, and cascading water flows from pond to pond.

## Pumped hydro energy storage (PHES)

The PHES candidates will be modelled as closed systems where the amount of water available to cycle between upper and lower reservoirs is assumed to be constant throughout the technical life of the asset.

AEMO will model PHES options equivalent to six, 12, 24, and 48 hours of energy in storage. This portfolio of candidates will complement deep strategic initiatives (the Snowy 2.0 and the Battery of the Nation projects).

Build costs and locational costs for these pumped hydro storage sizes have been obtained from Entura<sup>47</sup>. The cost projections of these four different pumped hydro sizes for future years are determined by the rate of capital cost reduction of six hours pumped hydro storage, given in the CSIRO GALLM report.

---

<sup>46</sup> AEMO Market Modelling Methodology Paper, August 2019, at [https://www.aemo.com.au/-/media/Files/Electricity/NEM/Planning\\_and\\_Forecasting/Inputs-Assumptions-Methodologies/2019/Market-Modelling-Methodology-Paper.pdf](https://www.aemo.com.au/-/media/Files/Electricity/NEM/Planning_and_Forecasting/Inputs-Assumptions-Methodologies/2019/Market-Modelling-Methodology-Paper.pdf).

<sup>47</sup> Entura, 2018, Pumped hydro cost modelling, at <https://projectmarinus.tasnetworks.com.au/assets/Report-Pumped-Hydro-Cost-Modelling.pdf>.

Table 7 below presents the regional build costs for the four different pumped hydro storage sizes derived from the Entura data. Where build costs and built limits are given for sub-regions, volume weighted build costs are used as regional build costs.

**Table 7 Regional build costs of pumped hydro for different storage sizes**

Region	MW weighted build cost (\$/kW)			
	6-hour storage	12-hour storage	24-hour storage	48-hour storage
New South Wales	1,578	1,805	2,119	2,512
Queensland	1,530	1,830	2,084	2,944
South Australia	1,930	2,640	3,750	-
Tasmania	1,160	1,280	1,390	1,570
Victoria	1,530	1,750	2,250	3,380

Entura outlined the cumulative amount of storage available per NEM region for each storage size (6-hour storage, 12-hour storage, 24-hour storage, and 48-hour storage). For example, Entura identified 1,200 MW of available 6-hour and 12-hour storage locations in Victoria, 700 MW of 24-hour storage, and 400 MW of 48-hour storage. However, these storage limits were not mutually exclusive; for every MW of 48-hour storage developed, there may be one MW less storage of smaller depth available.

This could be incorporated in the capacity expansion modelling through bespoke constraints. However, to avoid creating unwarranted computational burden, AEMO will instead apply a pre-allocated approach in initially determining the limits applied to all pumped storage depth options in each NEM region, based on storage depth preferences observed in AEMO’s ISP PHES Insights modelling<sup>48</sup>. Acknowledging the pre-determined nature of these limits, AEMO will apply further refinements and adjustments to the limits based on modelling outcomes, if these limits prove to be overly constraining.

This approach will allow the capacity expansion model to identify a suite of storage candidates across the forecast horizon, addressing evolving challenges that are mitigated by alternative storage duration options. AEMO will refine the storage limits where reached by “shifting” capacity from higher duration candidates to smaller duration if identified as of greater value by the model.

For example, based on these limits in Victoria, if the model identifies the need for 1,200 MW of 6-hour storage and only 600 MW for 12-hour storage, AEMO would then explore increasing the 6-hour limit by reallocating capacity from the 12-hour candidates. This approach allows for large duration candidates to be repurposed if under certain scenarios shorter duration storage provides for a more efficient outcome.

## Batteries

Large-scale battery expansion candidates will be modelled based on fixed energy to storage ratios. The batteries will have the flexibility to charge and discharge to achieve the optimal outcome for the system.

Battery storages will be considered as build candidates of both 2-hour and 4-hour duration depths for 2019-20 modelling. Battery round-trip efficiency is assumed to be 81% – equivalent to a 90% charge and 90% discharge efficiency. Battery storages’ deterioration, in terms of efficiency, power, or capacity, will not be modelled, given the computational complexity of incorporating degradation (particularly in capacity outlook models). However, like all technologies, the battery will retire at the end of its technical life, which is set to 15 years for batteries (approximating the expected warranted technical life).

<sup>48</sup> ISP Insights – Building power system resilience with pumped hydro energy storage, at [https://www.aemo.com.au/-/media/Files/Electricity/NEM/Planning\\_and\\_Forecasting/ISP/2019/ISP-Insights---Building-power-system-resilience-with-pumped-hydro-energy-storage.pdf](https://www.aemo.com.au/-/media/Files/Electricity/NEM/Planning_and_Forecasting/ISP/2019/ISP-Insights---Building-power-system-resilience-with-pumped-hydro-energy-storage.pdf).

The cost of battery disposal is not considered, as cost information on this activity is not within AEMO's data sets. This may understate the full life-cycle cost of the technology. In replacing retired technologies AEMO assumes a greenfield development, which may overstate the effective cost of replacement. In the absence of better data sets, AEMO considers it reasonable that these two factors balance out the total life-cycle costs.

### **Solar thermal technology**

AEMO will model a solar thermal central receiver with an 8-hour storage size, as in the 2018 ISP. AEMO's capacity outlook modelling will treat the storage component as a controllable battery storage object, rather than applying a static storage discharge trace.

To manage computational complexity, if the technology does not demonstrate reasonable adoption across the scenarios, subsequent simulations beyond initial technology screening will reinstate a static charge/discharge trace to minimise the computation burden of dynamic storage management.

### **Hydrogen**

Hydrogen facilities will not be directly considered as part of the 2019-20 ISP, however AEMO will provide an assessment of the potential impacts of a transition to a hydrogen economy on the 2020 ISP results. Furthermore, AEMO will continue to investigate the potential of this technology for potential inclusion in future ISP modelling.

#### **3.3.4 Weighted Average Cost of Capital (WACC) and social discount rate**

AEMO will apply the same discount rate (5.90% in most scenarios) for the WACC and Net present value (NPV) calculations sourced from Energy Networks Regulatory Investment Test for Transmission (RIT-T) handbook<sup>49</sup> and consistent with the RIT-T guidelines.

AEMO will adopt this WACC for all generation and transmission options in a technologically agnostic manner. AEMO considers that applying technology-specific values, particularly applying a risk premium to emissions-intensive generation technologies, is unlikely to significantly impact the outcomes, given technology cost movements of renewable energy projects relative to thermal alternatives.

Project finance costs may vary across scenarios, given the expected availability of investment capital in each scenario narrative. For the Slow Change scenario, AEMO will apply a higher WACC, given that scenario's settings are associated with lesser economic stimulation and lower economic conditions. For that scenario, AEMO will apply a 2% uplift, increasing the WACC from 5.9% real, pre-tax to 7.9%.

## **3.4 Existing generator assumptions**

### **3.4.1 Generator operating parameters**

#### **Forced outage rates**

Forced outage rates are a critical input for AEMO's reliability assessments and for modelling the capability of dispatchable generation capacity more generally. AEMO collects information from all generators on the timing, duration, and severity of unplanned forced outages, via an annual survey process. This data is used to calculate the probability of full and partial forced outages, which are randomly applied to each generating unit in market modelling.

In the 2019 ESOO, AEMO has determined specific outage information for each power station derived by:

- Conducting generator survey to collect availability data for summer 2018-19; supplementing historical data collected in previous years.

---

<sup>49</sup> RIT-T Handbook, at [https://www.energynetworks.com.au/sites/default/files/ena\\_rit-t\\_handbook\\_15\\_march\\_2019.pdf](https://www.energynetworks.com.au/sites/default/files/ena_rit-t_handbook_15_march_2019.pdf).



- Analysing the historical time series of outage information to identify potential changes in performance over time. Based on this analysis, forced outage rates have been derived based on the most recent four years of data only. This approximates well the longer-term outage rates seen by most technologies, but also recognises the statistically significant deterioration in performance of brown coal generation seen in recent years in particular.
- Submitting proposed assumptions on future reliability to power station owners and providing opportunity for this assumption to be revised based on further evidence. In one instance, outage rates were revised due to a power station owner providing evidence that recent maintenance carried out is reasonably expected to improve the future reliability of plant.
- Hydro and smaller OCGT generators use outage rates based on the average performance of these technologies.

More information about the calculation of forced outage rates is provided in AEMO's 2019 Reliability Forecasting Methodology report<sup>50</sup>. For the 2019-20 ISP, AEMO will aggregate all forced outage parameters by technology to protect the confidentiality of the individual data provided.

### Auxiliaries

AEMO's models dynamically take into account auxiliary load based on generator dispatch in each modelling interval. AEMO currently sources per unit auxiliary rate assumptions from GHD's 2018 AEMO Costs and Technical Parameter Review<sup>51</sup>.

### Retirements

For existing generators, AEMO will apply expected closure years provided by generators through AEMO's Generation Information<sup>52</sup> page for the Central scenario.

AEMO assesses the cost of mid-life refurbishments on high-utilisation thermal assets (such as coal and CCGTs), to ensure the ongoing operation at high loading is efficient and presents the least financial cost to the system, taking into account the large capital outlay associated with mid-life turbine refurbishment.

Coal refurbishment costs are applied to the annual operations and maintenance cost in the year of refurbishment. The refurbishment year is approximated as each tenth year preceding the closure year. For example, for a generator with a closure year of 2035, a refurbishment is scheduled at 2025, and for a generator with a closure of 2048, refurbishments are scheduled at 2038 and 2028. This approach captures the financial impact of asset refurbishment in the least-cost assessments without impacting the complexity of the optimisation model.

AEMO will also assess the revenue sufficiency of existing coal-fired generation and CCGTs (particularly at assumed time of mid-life refurbishments) to determine whether the economic life may be shorter than the unit's technical life. For CCGTs, this will include assessing whether conversion to an OCGT may be economically viable.

Possible extensions to the nominated closure year of coal generators will be modelled in the Slow Change scenario through additional refurbishments costs. In this scenario, AEMO will extend the closure year of all coal generation by 10 years and apply an additional refurbishment cost at the original closure year. The optimal closure therefore will be calculated by the capacity outlook models; the refurbishment cost will be avoided if the value of that life extension in minimising system costs is not greater than the cost of the refurbishment itself.

<sup>50</sup> AEMO, Reliability Forecasting Methodology Paper, at [https://www.aemo.com.au/-/media/Files/Stakeholder\\_Consultation/Consultations/NEM-Consultations/2019/Reliability-Forecasting-Methodology/2019-Reliability-Forecasting-Methodology-Paper.pdf](https://www.aemo.com.au/-/media/Files/Stakeholder_Consultation/Consultations/NEM-Consultations/2019/Reliability-Forecasting-Methodology/2019-Reliability-Forecasting-Methodology-Paper.pdf).

<sup>51</sup> At [https://www.aemo.com.au/-/media/Files/Electricity/NEM/Planning\\_and\\_Forecasting/Inputs-Assumptions-Methodologies/2019/9110715-REP-A-Cost-and-Technical-Parameter-Review---Rev-4-Final.pdf](https://www.aemo.com.au/-/media/Files/Electricity/NEM/Planning_and_Forecasting/Inputs-Assumptions-Methodologies/2019/9110715-REP-A-Cost-and-Technical-Parameter-Review---Rev-4-Final.pdf).

<sup>52</sup> AEMO, Generation information, at <https://www.aemo.com.au/Electricity/National-Electricity-Market-NEM/Planning-and-forecasting/Generation-information>.



For new technologies, AEMO will apply the technical life of the asset, which effectively retires new builds according to the technical life assumptions. For some technologies with a relatively short operating life (such as batteries), and early developments, there may be instances of greenfield replacement of new developments. While replacements are not greenfield in nature typically, technology improvements often mean that much of the original engineering footprint of a project may require redevelopment. Brownfield replacement costs therefore may require site-by-site assessments, and this data is not available for the 2019-20 ISP.

Site repatriation costs are incorporated in the 'closure costs' of each generation technology, excluding battery storage technologies where disposal cost data is not known (as discussed in Section 3.3.3).

### 3.4.2 Fuel prices

For generator fuel costs, AEMO applies the following sources:

- Natural gas prices and forecasting method – Core Energy Group.
- Coal prices and forecasting method – Wood Mackenzie.
- Renewable resource profiles and availability – DNV-GL.

The detail and source location of each of these reports is contained in Table 1, in Section 1.2.

Figure 20 presents updated regional gas prices for CCGT GPG for the Central scenario, and Figure 21 presents updated regional prices for coal generators for the Central scenario.

Peaking generation incurs a gas price premium to reflect the relatively low volumes these generators consume and the pass-through of peak supply costs, including, for example, the cost of using gas storage facilities or the use of gas transmission linepack.

**Figure 20 Regional gas prices to apply in the Central scenario for new entrant CCGT plant**



**Figure 21 Regional coal prices to apply in the Central scenario**

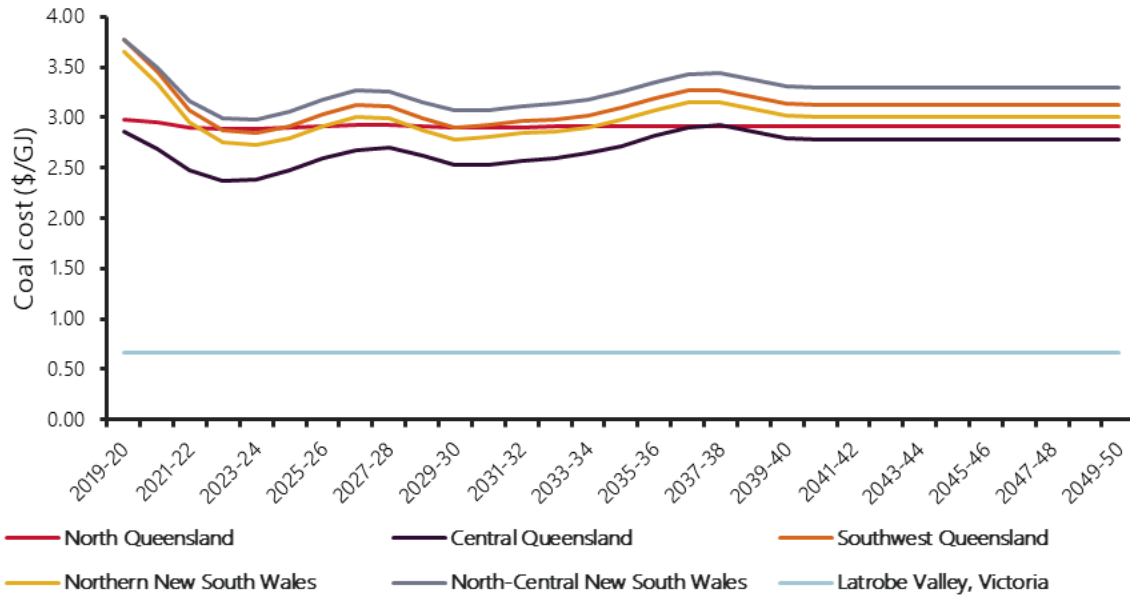

### 3.4.3 Minimum stable levels, unit commitment and other technical assumptions

In long-term planning studies, AEMO applies reasonable assumptions related to operational characteristics of plant, to project future investment needs. It is recognised that the actual limits and constraints that would apply in real-time operations will depend on a range of factors, as the real-world conditions will often vary to some extent from those assumed in planning projections, no matter how reasonable the assumptions applied.

The objective of the capacity outlook models in combination is to minimise the capital expenditure and generation production costs over the long-term planning outlook, subject to:

- Ensuring there is sufficient supply to reliably meet demand at the current NEM reliability standard, allowing for inter-regional reserve sharing.
- Meeting current and likely policy objectives.
- Observing physical limitations of the generation plant and transmission system.
- Accounting for any energy constraints on resources.

In the capacity outlook models, the relative coarseness of the models requires that these limitations are applied using simpler representations, such as minimum capacity factors, to represent technical constraints or likely gas consumption. This helps ensure that relatively inflexible coal-fired generators are not dispatched intermittently, and that likely gas consumption is not under-estimated at this initial stage.

Minimum and maximum capacity factors are informed through analysis of historical behaviours, and through endogenous application of the iterative nature of the layered market models. That is, the capacity outlook models are informed initially by applying capacity factors limits that reflect physical constraints, such as fuel delivery constraints, which may be identified through historical analysis and refined as informed by more detailed time-sequential analysis<sup>53</sup>. Therefore, the capacity factors limits reported in AEMO’s 2019 Inputs and Assumptions workbook represent starting conditions for the 2019-20 ISP modelling but may change during model iterations.

<sup>53</sup> Physical constraints can manifest in many forms, including fuel supply or delivery constraints. For example, CLP Holding’s 2019 Interim Results identified that Energy Australia’s Mt Piper coal-fired power station was impacted by coal supply constraints. At [https://www.clpgroup.com/en/Investors-Information-site/Announcements%20and%20Circulars/2019/e\\_Interim%20Results%20Announcement\\_2019\\_Final.pdf](https://www.clpgroup.com/en/Investors-Information-site/Announcements%20and%20Circulars/2019/e_Interim%20Results%20Announcement_2019_Final.pdf).

Minimum stable levels are defined by the minimum of observed historical performance of generators over the past several years, and the generator performance standards. AEMO maintains a register of generator performance standards<sup>54</sup>. These limits are applied for baseload generators only in the capacity outlook models, and for baseload and mid-merit generators in the time-sequential models. If a baseload plant was identified to be operating at low utilisation levels, the iterative modelling may relax the application of minimum stable levels in each model.

Unit commitment optimisation and minimum stable levels are not relevant for peaking plant when using an hourly model resolution, and are therefore not included in the market models. These technologies are capable of starting up to operate for minutes rather than hours, and it is inappropriate to constrain operations for an entire hour if dispatched. These peaking units also do not materially impact the annual gas consumption that would need to be reflected in the gas-electricity integrated market model.

AEMO will model all other cost and technical assumptions in accordance with the 2019 Inputs and Assumptions Workbook. This workbook includes technical data of each existing and new-entrant generator, including fuel costs, outage rates, build limitations, and other factors captured within the modelling.

## 3.5 Renewable energy zones

REZs are areas in the NEM where clusters of large-scale renewable energy can be efficiently developed, promoting economies of scale in high-resource areas, and capturing important benefits from geographic and technological diversity in renewable resources.

An efficiently located REZ can be identified by considering a range of factors, primarily:

- The quality of its renewable resources.
- The cost of developing or augmenting transmission connections to transport the renewable generation produced in the REZ to consumers.
- The proximity to load, and the network losses incurred to transport generated electricity to load centres.
- The critical physical must-have requirements to enable the connection of new resources (particularly inverter-based equipment) and ensure continued power system security.

Geographical boundaries of proposed REZ candidates are modelled at a high level and do not reflect detailed planning considerations. These, along with community consultations, are intended to be addressed in greater detail by transmission network service providers (TNSPs) during the RIT-T process.

REZ candidates were developed in consultation with stakeholders for the 2018 ISP and used as inputs to the models. The 2018 ISP identified a number of highly valued REZ candidates across the NEM with good access to existing transmission capacity. To connect renewable projects beyond the current transmission capacity, further action will be required (for example, increasing thermal capacity, system strength, and developing robust control schemes). After the 2018 ISP, the REZ candidates were further refined as outlined below.

The 2019-20 ISP will continue to consider how to best develop REZs in future that are optimised together with necessary power system developments, identifying indicative timing and staging that will best coordinate REZ developments with identified transmission developments to reduce overall costs.

### 3.5.1 REZ candidates

During the 2018 ISP project, 34 REZ candidates were identified across the NEM, through consideration of a mix of resource, technical, and other considerations. The purpose of this analysis was to identify the timing, scale, and location of REZs that would minimise the total cost of supply to consumers.

AEMO's selection of REZ candidates was conducted in early 2018, through formal consultation, industry working groups, and advice from consultants. This approach considered the following factors:

---

<sup>54</sup> Generator performance standards – further information at <https://www.aemo.com.au/Electricity/National-Electricity-Market-NEM/Security-and-reliability/Generator-performance-standards>.

- Wind resource – a measure of high wind speeds (above 6 metres per second [m/s]).
- Solar resource – a measure of high solar irradiation (above 1,600 kW/m<sup>2</sup>).
- Demand matching – the degree to which the local resources correlate with demand.
- Electrical network – the distance to the nearest transmission line.
- Cadastral parcel density – an estimate of the average property size.
- Land cover – a measure of the vegetation, waterbodies, and urbanisation of areas.
- Roads – the distance to the nearest road.
- Terrain complexity – a measure of terrain slope.
- Population density – the population within the area.
- Protected areas – exclusion areas where development is restricted.

Since the 2018 ISP, AEMO has received significant stakeholder feedback as part of the consultation process, and through government and TNSP workshops.

Based on the feedback provided and observed development interest, AEMO has made the following changes to the 2019 REZ candidates:

- The former Northern New South Wales Tablelands and New England REZs have been joined and redrawn, primarily to reflect the commonality of transmission infrastructure and expansion options.
- The former Central New South Wales Tablelands and Central West New South Wales REZs have been joined and redrawn, also primarily to reflect the commonality of transmission infrastructure and expansion options.
- The former Murray River REZ was split into two separate zones and redrawn to reflect how the transmission expansion options can be better considered separately.
- Tasmanian REZs were refined to focus on areas with observed generator connection interest.
- The Gippsland REZ in Victoria was expanded to include offshore wind capability.
- The former Moyne REZ was expanded to include a greater area of South West Victoria.

In addition to the above, the following zones have been added to the 2019 REZ candidate list to capture generator connection interest, network characteristics, and network expansion options:

- Wide Bay (Queensland).
- Wagga Wagga (New South Wales).
- Central North Vic (Victoria).

Figure 22 below shows the 2019 REZ candidates to be considered in the 2019-20 ISP.

Figure 22 REZ candidates for 2019-20 ISP

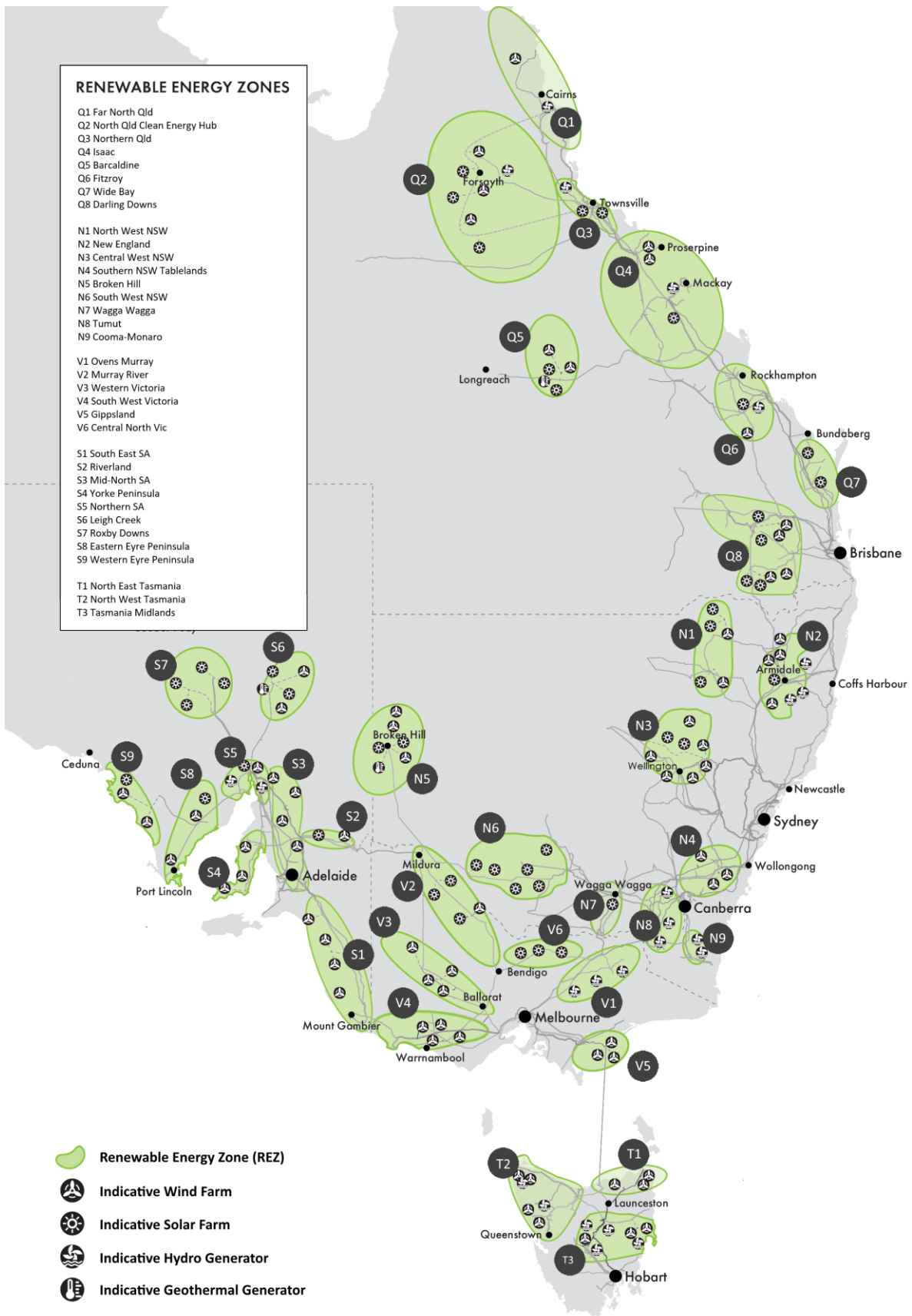

## Renewable generation resource profiles

For AEMO's planning models, energy availability data for individual wind and solar generators reflect the available renewable energy resource, as calculated by DNV-GL. Figure 23 below illustrates the relative strength of the underlying renewable energy resource for each of these technologies (in these figures, green represents a stronger resource, red represents a weaker resource).

**Figure 23 Weighted wind (left) and solar (right) resource heat map**

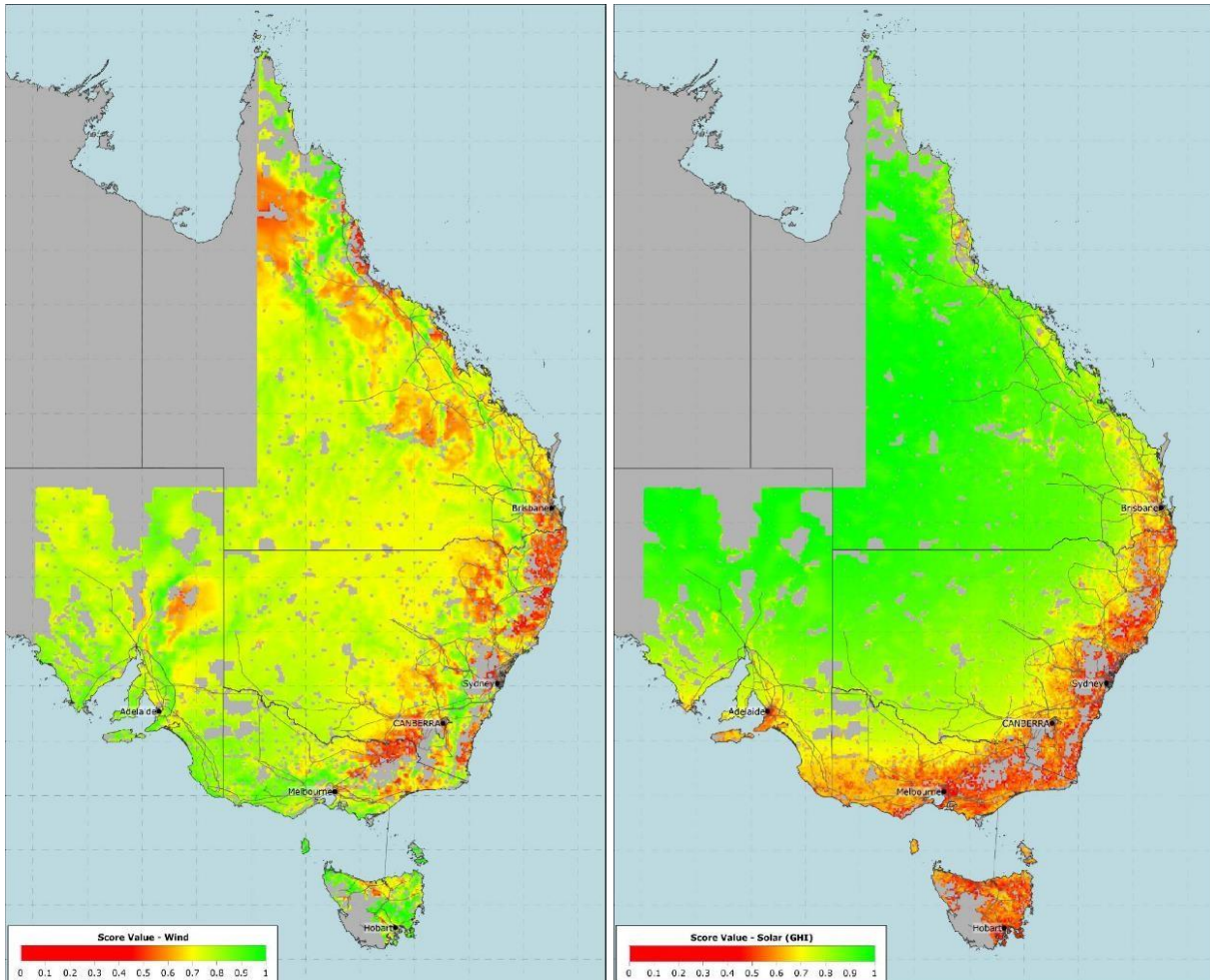

### 3.5.2 REZ cost assumptions

There are several important costs to consider when estimating the cost of a REZ:

- REZ network expansion costs – the cost of expanding the transmission network to provide access for generator and storage connections.
- Connection costs – the cost of connecting a generator to the hub of the REZ (that is, the local high-voltage network).
- Generator costs – the cost involved in establishing generation or energy storage projects.

An example of how these costs are allocated is shown in Figure 24.



**Figure 24 Division of REZ costs**

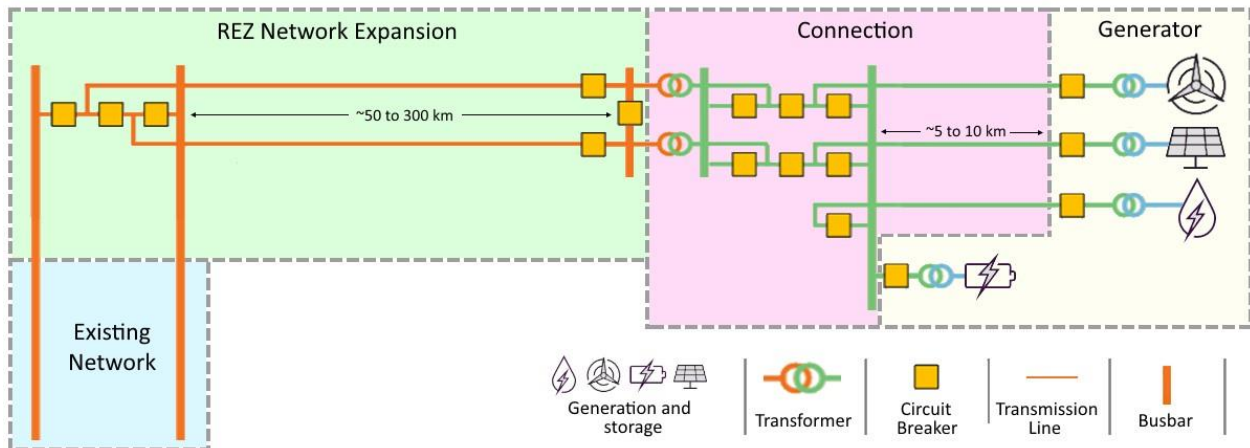

Note: The connection cost of battery storage is lower than other storage and generation options because battery storage has more flexibility in its location. Due to resource location, wind, solar, and PHEs projects will often be located 5-10 km from the existing network.

### REZ connection and network expansion costs

REZ connection and network expansion costs consider increasing network capacity to a REZ. In some instances, this could require building new transmission, and in others, could require upgrading existing transmission. These costs are generally dominated by the cost of long transmission lines. This cost component generally includes:

- Circuit breakers and switchgear at an existing substation.
- Transmission line (for example, 50 to 300 km per line).
- Substation site establishment (15,000 square metres).
- Communication (SCADA).
- Provision of local system strength via plant such as synchronous condensers where required.

REZ connection and network expansion costs are listed in the 2019 Inputs and Assumptions Workbook for each REZ and technology. These costs vary based on specific network characteristics such as voltage, terrain, technology, and distance of resources to transmission infrastructure.

### 3.5.3 Network losses

Network losses occur as power flows through transmission lines and transformers. Increasing the amount of renewable energy connected to the transmission network remote from load centres will increase network losses. As more generation connects in a remote location, the higher the power flow over the connecting lines and on the alternating current (AC) system, and the higher the losses.

In the NEM, transmission network losses are represented through Marginal Loss Factors (MLFs). The modelling calculated network losses by applying the methodology described in AEMO's "Forward-Looking Transmission Loss Factors"<sup>55</sup>.

### Marginal Loss Factors

Energy is lost as it travels through the transmission network, and these losses increase in proportion to the distance between the generator and the loads, and the square of the amount of current being carried by the transmission network. In the NEM, MLFs are applied to market settlements, adjusting payments to reflect the impact of incremental energy transfer losses.

<sup>55</sup> At [http://www.aemo.com.au/-/media/Files/Electricity/NEM/Security\\_and\\_Reliability/Loss\\_Factors\\_and\\_Regional\\_Boundaries/2017/Forward-Looking-Loss-Factor-Methodology-v70.pdf](http://www.aemo.com.au/-/media/Files/Electricity/NEM/Security_and_Reliability/Loss_Factors_and_Regional_Boundaries/2017/Forward-Looking-Loss-Factor-Methodology-v70.pdf).



For generation, an MLF represents the amount of electricity delivered to the regional reference node<sup>56</sup> for a marginal (next megawatt) increase in generation; for a load, the MLF represents the amount of power that would need to be generated at the regional reference node for a marginal (next megawatt) increase in demand.

In simple terms, a higher MLF is good for a generator's revenue, while a lower MLF is good for a load (as it means lower payment for energy lost before it reaches the load). MLFs will change over time, most often decreasing as additional generation connects in an area.

MLFs are used to adjust the price of electricity in a NEM region, relative to the regional reference node, in a calculation that aims to recognise the difference between a generator's output and the energy that is actually delivered to consumers throughout the year. In dispatch and settlement in the NEM, the local price of electricity at a connection point is equal to the regional price multiplied by the MLF.

A renewable generator's revenue is directly scaled by its MLF, through both electricity market transactions and any revenue derived from LGCs created if accredited under the LRET.

Increasing generation within a REZ is likely to increase losses between the REZ and the regional reference node, decreasing the MLFs for the REZ. The MLFs attributable to generators located in some REZs will be more sensitive to change as a result of new connecting generators than other REZs, particularly where they are distant from major load centres and transmission is relatively weak.

Investors in new generation are concerned about the effect of lower MLFs on their potential returns, and the uncertainty of how MLFs can vary from one year to the next. Generators in locations that are strongly connected to major load centres have MLFs that are less likely to change over time.

A range of factors affect how much the MLF at a given connection point will change:

- **Transmission and distribution network** – if new generation is added at an electrically distant connection point, the MLF decreases by more than if it had been added close to the high-voltage network.
- **Generation profile in the area** – if new generation is only running at the same times other nearby generators are also running, the MLF decreases by more. For example, solar generators in an area all produce power at the same time, so adding more of this type of generator will decrease the MLF more than if a different technology generator was added.
- **Load profile in the area** – if new generation mainly produces power at times when there is light load in the area, the decrease in MLF will be greater.
- **Intra-regional and inter-regional flows** – wider trends affecting MLFs include decreasing consumption, increasing distributed generation, changing industrial loads, and retiring generators.

Examples of events causing large changes in power flow across the transmission network, and corresponding large changes in MLFs, include:

- **New generator connections** – the planned connection of over 1,200 MW of new solar generation in north and central Queensland led to MLFs falling by up to 12% from the 2017-18 financial year to 2018-19.
- **Retirement of generation** – the retirement of Northern Power Station in South Australia in 2016 caused power flow from Victoria to South Australia to increase, contributing to MLFs in south-east South Australia falling by around 6%. The retirement of Hazelwood Power Station in Victoria in 2017 resulted in increased power flow south from Queensland and New South Wales, contributing to a reduction in northern New South Wales MLFs of around 5%.
- **Change in fuel mix** – the availability of cheap "ramp" gas in Queensland in 2014 and 2015 led to an increase in GPG in southern Queensland. This caused increased power flow from Queensland to New South Wales, contributing to MLFs in northern New South Wales falling by up to 10%.
- **Changes in electrical load** – the closure of the Point Henry Aluminium Smelter in Victoria in 2014 contributed to MLFs in the area falling around 2.5%.

---

<sup>56</sup> The reference point (or designated reference node) for setting a region's wholesale electricity price.

The projected increase in development of renewable generation across the NEM will result in changes to network flow patterns, the network itself where augmentations or new interconnection is undertaken, and network losses as different parts of the network are utilised in different ways. This means MLFs will change.

In AEMO's planning and forecasting studies, especially relating to REZs, it is important to model the transmission system and its losses. Each candidate REZ is studied to assess the sensitivity of its MLF to increased renewable generation, based on the existing network. The results are used as a guide to determine how sensitive each proposed REZ would be to changes in MLFs.

AEMO's ISP studies will consider each REZ individually, by using the existing network as a basis and simulating various levels of new renewable generation connected in the REZ, to calculate the projected MLF as new generation connects. The MLFs calculated are only indicative and are not determined using the full Forward Looking Loss Factor Methodology<sup>57</sup> applied under the National Electricity Rules. The studies use existing electrical system strength levels and the existing generation and load profiles and consider some proposed network augmentations.

### **Effect of energy storage on MLFs**

The effect of energy storage on MLFs depends on how well charging and discharging profiles correlate with the generation profile and load profile. The MLF of a site would improve if the energy storage is charging at times when the generation of the REZ is high and the local area load is low. For example, co-locating a battery with a solar farm could not only assist in shifting the output to times when needed, but could also improve the MLF for the site.

In the 2019-20 ISP, AEMO will not attempt to optimise the interactions between storages and MLFs, but generation and transmission expansions will be validated by time-sequential modelling and power system analysis which may also investigate the impact storage installations across a region may have on REZ MLFs.

### **Modelling MLFs in capacity expansion**

It is important to note that areas of robust MLFs are intrinsically linked with bulk transfer capacity and strong networks. Generators connecting at 330 kilovolts (kV) and above tend to have more robust MLFs. Conversely, generators connecting at lower transmission voltages have less robust MLFs.

Developing and applying dynamic loss factors in the ISP is not practical at this time, given the necessary complexity of the broader models. Rather, AEMO applies an iterative approach, broadly described as follows:

- Existing MLFs for generation in a given location will be used as a first pass for generation and network expansion. In this first pass, the capacity outlook model may decide to increase network capacity to accommodate the new generation.
- After running the model, each new generator's MLF will be tested to validate the outcome. If the MLF changes materially, the modelling will be repeated to determine if the change in MLF is likely to result in an alternative site being picked.
- A power system analysis phase occurs, which considers intra-regional transmission augmentation as a means to increase overall transfer capacity of the REZ, as well as improving MLF in response to the generation sites being picked after running the model. Where needed, alterations to the inputs of the model are applied to capture the outcomes of the previous iteration.

The level of detail that AEMO will investigate and publish for each REZ will be determined by the optimal timing of that REZ:

- REZs that are urgently required will be explored in the most detail – with multiple network and non-network options considered and consulted on. Detail will include bespoke cost estimates, material issues on MLF, system strength, route selection, and both thermal limits and stability limits.

---

<sup>57</sup> AEMO. Methodology for Calculating Forward-Looking Transmission Loss Factors, at <https://www.aemo.com.au/Electricity/National-ElectricityMarket-NEM/Security-and-reliability/Loss-factor-and-regional-boundaries>.

- REZs that are required within the next 10 years or so may need to be designed and planned soon. These REZs will be explored in moderate detail and will be refined in subsequent ISPs.
- REZs that are not required for 10 years or more will be assessed at a high level.

## 3.6 Network considerations

AEMO's forecasting and planning models are regional in nature and include network constraint equations to capture inter- as well as intra-regional limitations.

### 3.6.1 Network augmentation options

In the 2019-20 ISP, AEMO will consider the latest information that has been developed in active RIT-T assessments and will reassess and refine its development strategy.

The ISP modelling will only assume that proposed network upgrades will proceed once they have received final regulatory approval under the relevant framework (the RIT-T). Projects that are still under active assessment by TNSPs will be re-evaluated in the ISP.

The 2019 Inputs and Assumptions Workbook includes latest details of each interconnector augmentation to be considered in the 2019-20 ISP modelling – including cost, capacity, and descriptions. These details will be refined during the ISP analysis, in collaboration with the relevant TNSPs.

Cost estimates provided are indicative and appropriate for high level planning with a tolerance of  $\pm 50\%$ <sup>58</sup>. It includes site survey, primary plant, secondary plant, construction, testing and commissioning, and project management. It does not include land and easements and system testing to release the planned capacity.

The application of a single nominal transfer limit is required in AEMO's capacity outlook models to represent the limit ranges for each of the augmentation options. This single nominal transfer limit is calculated as the maximum capability during peak demand conditions in the importing region. In time-sequential modelling, separate constraint equations are used to identify intra-regional and inter-regional constraints. These may validate the single nominal transfer limits, and if necessary result in changes to the simplified representation during the modelling period.

### 3.6.2 Non-network technologies

AEMO considers potential non-network options alongside network solutions to develop an efficient power system strategy. Depending on their relative costs and benefits, the capital costs of large network augmentation could be deferred or avoided in some cases. Non-network options include a range of technologies, including:

- Generation investment (including embedded or large-scale).
- Storage technologies (such as battery storage and PHES).
- Demand response.

Some of the above, particularly storage technologies, have the potential to not only defer or avoid network augmentation, but can enhance the existing transfer capacity by providing power system services, and improving local MLFs. The 2019-20 ISP will investigate non-network alternatives to network developments that are identified during the course of the ISP and able to address an identified need.

### 3.6.3 System security constraints

A regional representation of the NEM is not explicitly capable of considering intra-regional power flows, either as a model result or for the purposes of modelling the physical limitations of the power system. In the

---

<sup>58</sup> Generation technology cost estimates provided by GHD are also uncertain and are typically either Estimating Class 5 estimates, order of magnitude, concept screening: -20% to +50%, or Estimating Class 4 estimates, study or feasibility: -15% to +30% depending on the level of definition of the generating plant.

real-time NEM Dispatch Engine (NEMDE), a series of network constraint equations control dispatch solutions to ensure that intra-regional network limitations are accounted for. The time-sequential model contains a subset of the NEMDE network constraint equations to achieve the same purpose.

The subset of network constraint equations includes approximately 2,500 to 3,000 pre-dispatch<sup>59</sup>, system normal equations reflecting operating conditions where all elements of the power system are assumed to be in service. They model important aspects of network operation and include contingency for maintaining secure operation in the event of outage of a single network element.

In general, the following constraint equations are included in the time-sequential model:

- Thermal – for managing the power flow on a transmission element so it does not exceed a rating (either continuous or short-term) under normal conditions or following a credible contingency.
- Voltage stability – for managing transmission voltages so that they remain at acceptable levels after a credible contingency.
- Transient stability – for managing continued synchronism of all generators on the power system following a credible contingency.
- Oscillatory stability – for managing damping of power system oscillations following a credible contingency.
- Rate of change of frequency (RoCoF) – for managing the rate of change of frequency following a credible contingency.

The effect of committed projects on the network is implemented as modifications to the network constraint equations that control flow. The methodology for formulating these constraints is in AEMO's Constraint Formulation Guidelines<sup>60</sup>.

A set of network constraints is produced and applied for every scenario modelled. This set may reflect:

- Extracted constraints from the AEMO Market Management Systems (MMS).
- Network augmentations appropriate for the scenario.
- Adjustments to reflect the impact of new generation capacities.
- Other adjustments to reflect assumptions of system operating conditions.

### **Excluded constraint equations**

Operationally, AEMO also uses other types of constraint equations that are invoked as required depending on system conditions. These may include:

- Outage constraint equations.
- Frequency control ancillary service (FCAS) constraint equations.
- Condition-specific constraint equations such as network support agreements.

These constraint equation types are commonly excluded from the market simulations, because they may be operational in nature or caused by transmission outage or non-credible events.

### **Shadow generators**

Investment in generation across the NEM is influenced by market signals and decided by private investors. Since the precise location and connection point of future generators is inherently uncertain, AEMO assumes future generation will be connected to nodes where there are already existing commissioned generators. This

---

<sup>59</sup> NEMDE contains equation sets for dispatch, pre-dispatch, Short Term Projected Assessment of System Adequacy (ST PASA), and Medium Term Projected Assessment of System Adequacy (MT PASA). Within these sets, other sets cover specific network conditions such as outages, rate of change, frequency control ancillary services, and network service agreements. Pre-dispatch equations are used because dispatch equations contain terms that rely on real-time SCADA measurements not available to simulation models.

<sup>60</sup> AEMO. Constraint Formulation Guidelines, at [http://www.aemo.com.au/-/media/Files/Electricity/NEM/Security\\_and\\_Reliability/CongestionInformation/2016/Constraint\\_Formulation\\_Guidelines\\_v10\\_1.pdf](http://www.aemo.com.au/-/media/Files/Electricity/NEM/Security_and_Reliability/CongestionInformation/2016/Constraint_Formulation_Guidelines_v10_1.pdf).

allows the new entrant power plant to 'shadow' the impact of the existing capacity to the network (thermal constraints and MLFs).

The criteria for selecting a node to connect the possible new entrant depend on:

- Available network capacity.
- Proximity to the specified zone the new entrant is modelled to be connected to.
- Access to fuel source (such as pipelines).

Existing thermal constraints are modified to reflect impact of these new entrant generators on the network.

### Inter-regional loss model

Losses on notional interconnectors are modelled using the MLF equations defined in the List of Regional Boundaries and Marginal Loss Factors report<sup>61</sup>. For most interconnectors, these are defined as a function of regional load and flow.

AEMO uses proportioning factors to assign losses on interconnectors to regions. Operationally, this is used to determine settlement surplus. In long-term modelling, proportioning factors are used to allocate losses to demand in each region. Proportioning factors are derived from MLFs. Proportioning factors are given in the annual List of Regional Boundaries and Marginal Loss Factors report.

#### 3.6.4 Modelling a South Australia to New South Wales interconnector

A new transmission connection between South Australia and New South Wales would create a loop between NEM regions (see Figure 25 below), which can affect market operation of the electricity market. This will require a review of NEM market design.

**Figure 25 Loop flow resulting from South Australia to New South Wales connection**

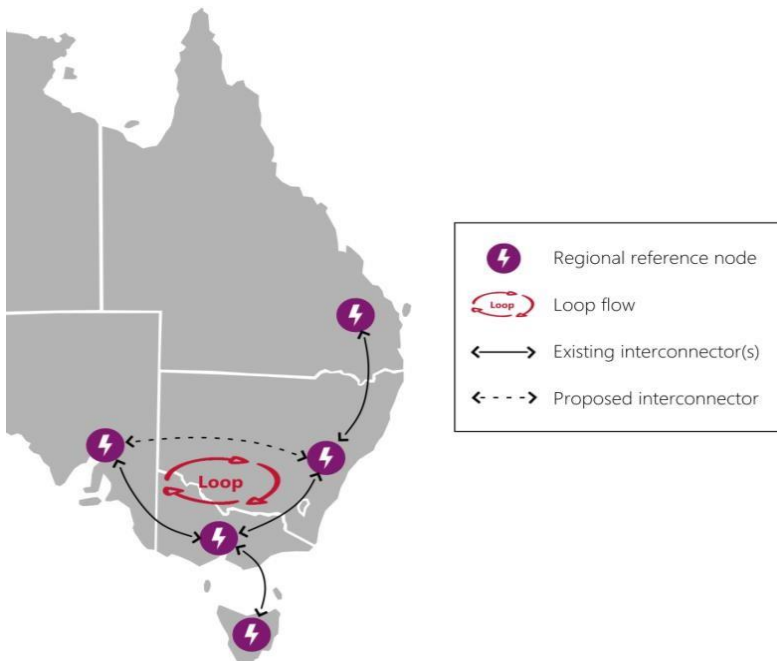

This loop in major transmission paths would require several key considerations:

- Separate parallel AC interconnectors are physically related and cannot be separately dispatched based on market forces (electricity flows through the path of least resistance). A form of flow-based market coupling will be required to ensure the physical relationship between the two interconnectors is maintained.

<sup>61</sup> AEMO, at <http://www.aemo.com.au/Electricity/National-Electricity-Market-NEM/Security-and-reliability/Loss-factor-and-regional-boundaries>.

- Models that determine transmission losses will become complex and may necessitate design changes to NEMDE.
- Under some constrained conditions, market prices can increase above the prices bid by generators (the “spring washer effect”).
- Inter-regional settlement residues will become more complex and may require market design solutions.

While adding a new interconnector to the electricity market model is feasible, an alternative is to redefine the regional boundaries. This would involve shifting the Victoria to New South Wales boundary slightly, so the South Australia to New South Wales interconnector connects to a portion of the Buronga substation that is redefined as being in Victoria (see Figure 26).

**Figure 26 Region boundary before (left) and after (right) possible boundary shift**

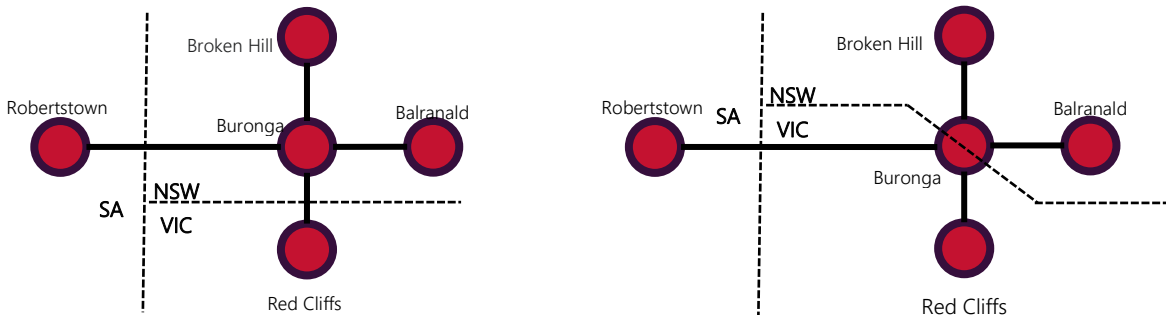

### Modelling approach

AEMO proposes the following assumption for modelling a South Australia to New South Wales link in this year’s planning and forecasting studies:

- In the capacity outlook model, a South Australia to New South Wales link will be explicitly modelled as connecting the South Australia and New South Wales regional reference nodes. This will facilitate least-cost investment decisions to be optimised based on physical network topology.
- In the short-term time-sequential model, a region boundary shift will be implemented. This avoids the pricing and constraint complexity of dealing with a loop flow (for example, the spring-washer effect, flow-based market coupling), and enables investment decisions from the capacity outlook model to be verified against a different market design.

If the South Australia to New South Wales interconnector proposal obtains the final regulatory approvals, AEMO will conduct a separate consultation to determine any required changes to the NEM market design, and the transmission will be incorporated into the ISP when and if it is committed.

## 3.7 Gas modelling assumptions

AEMO also considers the eastern and south-eastern Australian gas markets when optimising decisions for the development of the NEM, in recognition of gas and electricity sector coupling. Given the strongly integrated nature of the gas and electricity markets, any development or shortfalls in the gas market would have direct implications for the operation of GPG in the electricity market. Similarly, any significant shortfalls in electricity supply would have a significant impact on the capability of the gas market to operate.

Thus, as part of the modelling process, AEMO uses an integrated model to determine optimal developments considering both gas and electricity systems simultaneously, to ensure optimal outcomes for the energy system as a whole.

The gas portion of the integrated model utilises the model topology, input assumptions and settings developed for the 2019 GSOO<sup>62</sup>. The new supply options studied under the 2019 GSOO have been implemented as expansion options in this integrated model, utilising build costs derived from publicly available information for the chosen projects. The new supply options include:

- LNG import terminals.
- New field developments (Galilee Basin development, Narrabri gas project).
- Pipeline interconnection, including:
  - An upgrade and extension of the Northern Gas Pipeline.
  - Further pipeline interconnection between Queensland and New South Wales.

Assumptions relevant to the gas market are included in the 2019 Inputs and Assumptions workbook.

---

<sup>62</sup> 2019 GSOO report, modelling methodology, and supplementary materials, at <http://aemo.com.au/Gas/National-planning-and-forecasting/Gas-Statement-of-Opportunities>.



# 4. Inertia and system strength requirements methodologies

As an outcome from the Australian Energy Market Commission (AEMC) 'Managing the rate of change of power system frequency'<sup>63</sup> and 'Managing power system fault levels'<sup>64</sup> Rule changes, in July 2018 AEMO published its initial:

- Inertia Requirements Methodology, together with the first report on inertia requirements and shortfalls in the NEM<sup>65</sup>.
- System Strength Requirements Methodology, together with the first report on system strength requirements and fault level shortfalls in the NEM<sup>66</sup>.

These methodologies are used to identify and quantify shortfalls in inertia and system strength respectively.

Based on the inertia requirements methodology, AEMO identified the projected inertia shortfall for the South Australian region that was declared in the 2018 National Transmission Network Development Plan (NTNDP), published in December 2018.<sup>67</sup>

AEMO has not identified any necessary changes to the methodologies at this stage.

System strength and inertia requirements will continue to be considered as part of the analysis of power system requirements and transmission expansion, however, improvements are being made to incorporate any costs these requirements may impose on REZ connection.

---

<sup>63</sup> AEMC. Managing the rate of change of power system frequency, at <https://www.aemc.gov.au/rule-changes/managing-the-rate-of-change-of-power-system-freque>.

<sup>64</sup> AEMC. Managing power system fault levels, at <https://www.aemc.gov.au/rule-changes/managing-power-system-fault-levels>.

<sup>65</sup> AEMO. 2018 Inertia Requirements Methodology and 2018 Inertia Requirements and Shortfalls, at [http://aemo.com.au//media/Files/Electricity/NEM/Security\\_and\\_Reliability/System-Security-Market-FrameworksReview/2018/Inertia\\_Requirements\\_Methodology\\_PUBLISHED.pdf](http://aemo.com.au//media/Files/Electricity/NEM/Security_and_Reliability/System-Security-Market-FrameworksReview/2018/Inertia_Requirements_Methodology_PUBLISHED.pdf).

<sup>66</sup> AEMO. 2018 System Strength Requirements Methodology, System Strength Requirements and Fault Level Shortfalls, at [http://aemo.com.au//media/Files/Electricity/NEM/Security\\_and\\_Reliability/System-Security-Market-FrameworksReview/2018/System\\_Strength\\_Requirements\\_Methodology\\_PUBLISHED.pdf](http://aemo.com.au//media/Files/Electricity/NEM/Security_and_Reliability/System-Security-Market-FrameworksReview/2018/System_Strength_Requirements_Methodology_PUBLISHED.pdf).

<sup>67</sup> AEMO. 2018 National Transmission Network Development Plan, at <http://www.aemo.com.au/Electricity/National-Electricity-MarketNEM/Planning-and-forecasting/National-Transmission-Network-Development-Plan>.

# 5. Applying the scenarios in decision-making

The scenarios outlined in this report cover a wide range of plausible futures, from highly centralised and relatively carbon-intensive generation supply options (similar to the status quo), to highly decentralised and decarbonised generation supply options, with high penetration of renewable energy and electrification of other sectors such as transport.

Investment decisions are necessary, despite uncertainty regarding the likelihood of any given future NEM. In the presence of investment uncertainty, the theory of regret aversion proposes that investors must consider the potential regrets their actions may have over the investment timeframe, and attempt to reduce or eliminate these potential regrets.

Flexibility becomes critical, so decision-makers can adapt without incurring significant costs as the future unfolds and uncertainties reveal themselves. Many investment decisions in the context of energy involve the development (or not) of assets that both have a long development lead time and a long asset life once developed. This amplifies the potential risks sub-optimal decisions may have on the overall cost to the system, and to consumers.

The key benefits considered under the cost benefit analysis of the ISP are consistent with those outlined in the RIT-T guidelines published by the Australian Energy Regulator (AER)<sup>68</sup>. The ISP's scenarios and sensitivities are constructed to allow the identification of benefits of transmission augmentations with perfect foresight. With a suite of counter-factual sensitivities testing timing, capacity, and cost, the impact on market benefit classes can be quantified.

The key market benefit classes identified in the guidelines can be summarised below:

- Changes in fuel consumption arising through different patterns of generation dispatch.
- Changes in voluntary load curtailment.
- Changes in involuntary load shedding, with the market benefit to be considered using a reasonable forecast of the value of electricity to consumers.
- Changes in costs for parties, other than the RIT-T proponent, due to differences in the timing of new plant, capital costs, and operating and maintenance costs.
- Differences in the timing of expenditure.
- Changes in network losses.
- Changes in ancillary services costs.
- Competition benefits.
- Any additional option value (where this value has not already been included in the other classes of market benefits) gained or foregone from implementing that credible option with respect to the likely future investment needs of the market.

The importance of conducting these studies under an integrated approach with respect to multiple energy sectors cannot be overstated. The need to explore augmentation solutions to emerging challenges in the electricity and gas sectors requires an integrated approach. This allows for the potential identification of an electrification solution to an emerging gas limitation, and, similarly, a gas sector solution to electricity-based

---

<sup>68</sup> At [https://www.aer.gov.au/system/files/AER%20-%20Final%20RIT-T%20application%20guidelines%20-%202014%20December%202018\\_0.pdf](https://www.aer.gov.au/system/files/AER%20-%20Final%20RIT-T%20application%20guidelines%20-%202014%20December%202018_0.pdf).

challenges. By coupling these sectors, greater insights and system benefits can be quantified under the ISP scenarios.

For the ISP, AEMO will favour taking a modelling and reporting approach that maximises the transparency of its inputs, outcomes, and analyses, so stakeholders are well informed on the benefits, and risks, associated with various development options.

The option value of building in sufficient flexibility in any solution is particularly important in an uncertain decision-making environment, and maximising a solution's adaptability to future challenges will be critical to the planning of the power system.

By transparently investigating a broad suite of scenarios and sensitivities, AEMO can support informed decision-making to actively mitigate future risks.

AEMO's approach to determine the development plan across these un-weighted scenarios will be to:

- Determine the optimal development pathway in each scenario under the veil of perfect foresight, that maximises net market benefits to consumers.
- Identify investment decisions that need to be made now under each optimal development pathway to achieve these benefits.
- Impose these initial investment decisions on each alternative scenario and re-simulate to determine how the future development pathway would need to change if a different scenario is realised than assumed.
- Calculate the 'regret cost' of making one decision now and having to adapt to a different future to identify the 'least regret' decisions.

AEMO's proposed approach focuses on maximising transparency with respect to the risks and opportunities of various development pathways, and avoids the need to subjectively value the probability of any given scenario eventuating. This approach, and the rationale for ultimate identification of the recommended development pathway, will be discussed openly with stakeholders once draft results are available.